

**Rotor Rakes**  
Single, Twin, Four



# Andex Rotary Rakes



*My way of Farming!*





The iM Farming logo appears when the implement can be connected to our smart farming systems and accessories, essential for running your farm.

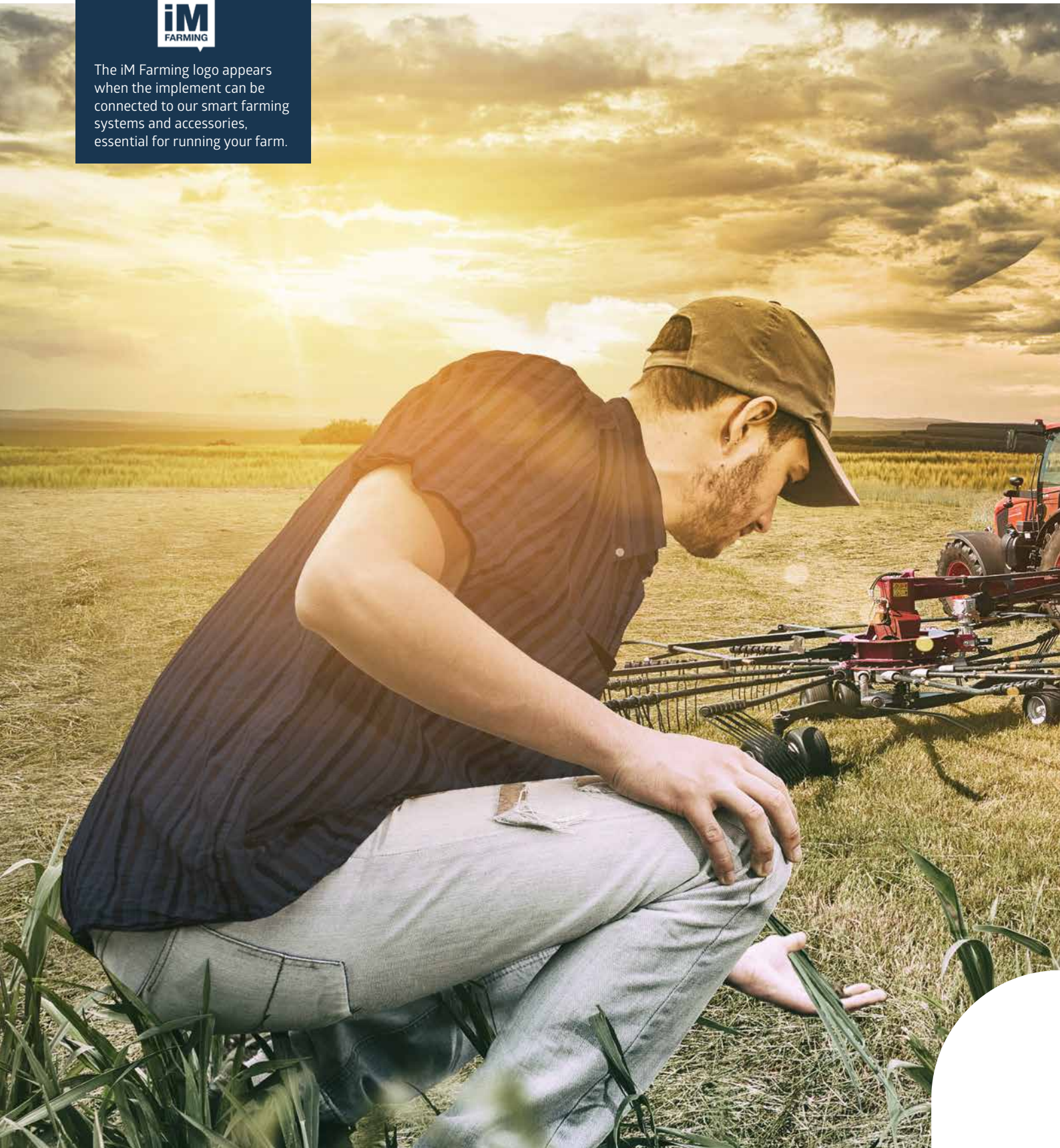



# KEEP YOUR SYSTEM RUNNING

*My way of Farming!*



Working the land, running my farm and connecting with nature. Farming is my way of living, and despite being rough at times, I never grow weary of everyday tasks of attending to my land and livestock. I keep up with developments by staying loyal to personal philosophies and applying the appropriate strategy.

I shape and influence my own future by combining craftsmanship with modern technology, employing the very best machinery. I actively seek new opportunities, by being innovative in my way of working. I work hard to grow a good crop. I am passionate about my livestock, providing my animals with only the best. My farm and its returns, reflects who I am, because my heart and soul is put into the work I do.

Farming is about passion, about growing and developing, my crop, my farm, myself, my way.



# Durability *Exemplified*

Steplessly adjustable cam track for easy adaptation to different amounts and sorts of crop.

Injection moulded aluminium tine arm support housings provide strength and reduced weight.

Pinion gear with two bearings separate from the main driveline, keeping pinion and crown wheel securely in place.

All rotor star axes including housing can be removed individually by just removing 3 bolts.

Flat 400mm cast iron cam track with optimised shape, for smooth tine arm control and reduced running speed.

**“***Helping You*  
to Do More”

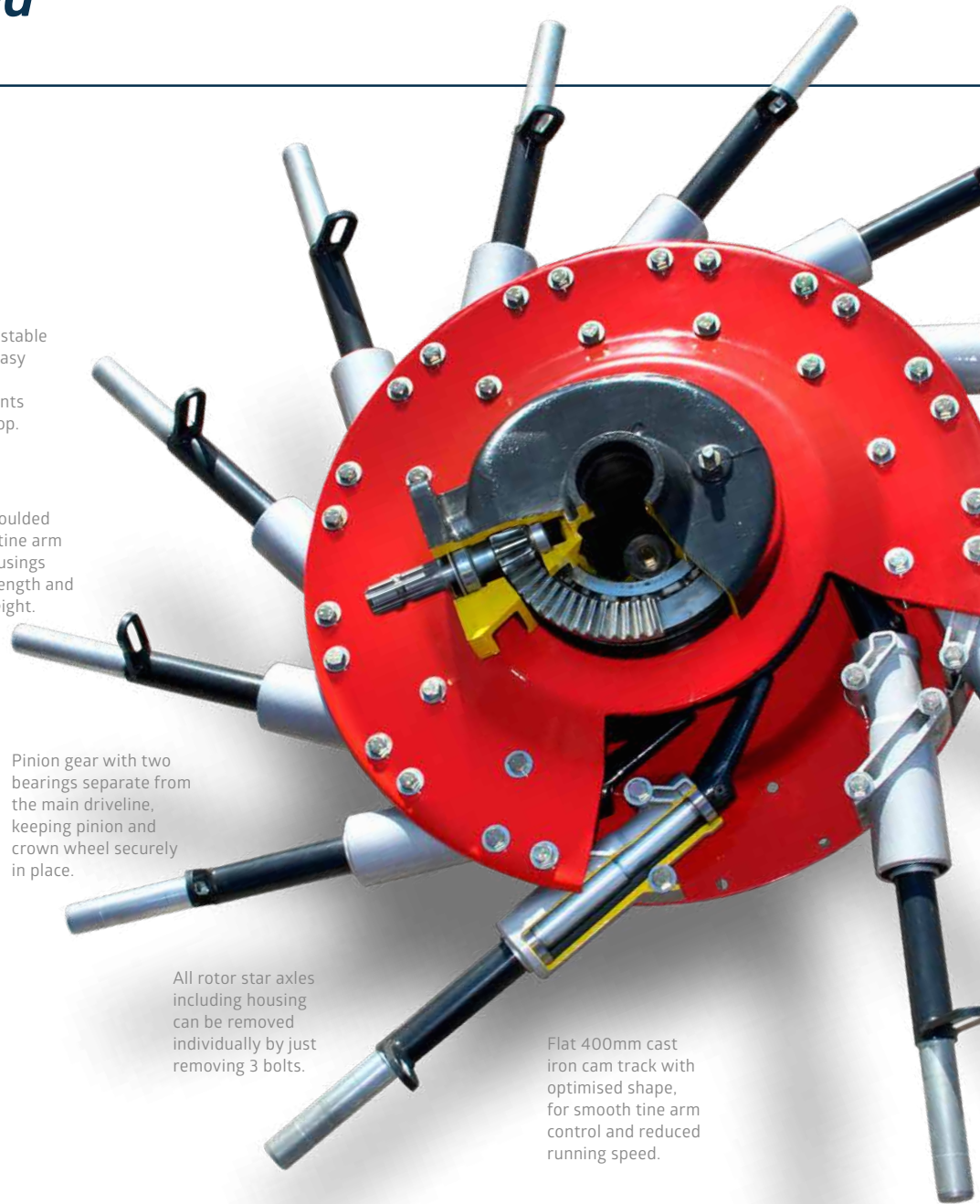





Oil-immersed crown wheel and pinion reduces wear to a minimum.

Heavy duty ball bearings with large distance for excellent support of tine arm shafts.

Guide rollers with hardened surface minimises wear on cam track and cam follower.

Unique 4-point ball bearing on crown wheel ensures efficient power transfer to the tine arms.

**ProLine**

The Andex ProLine rakes feature a unique drive system, which comprises oil-immersed pinion and crown wheels. The fully enclosed design ensures full and permanent lubrication, and makes the entire system absolutely maintenance-free.

Our extensive experience guarantees well-proven technology of the highest standard. The hardened cam track is adjustable and with an extremely large 400mm diameter, giving precise guidance to the tine arms and quiet machine running.

The optimised shape of the curve disc allows the tine arms to exit the crop faster, leaving a more uniform swath formation.

Aluminium bearing housings, with two integral ball bearings and wide support, provide solid and maintenance-free tine arm mounting. Additionally all tine arms including housing are removed by simply removing 3 bolts. Fast and easy!

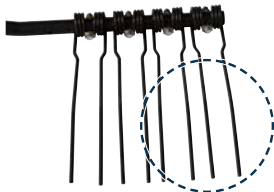

ProLine 10mm diameter tines.

Each tine arm can be dismantled and repaired individually.

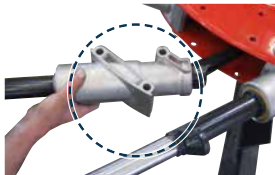



# Maintenance-Friendly *Solution*

Double bearings for crown wheel and pinion.

Maintenance-free cam track and tine arms, running in oil bath.

High tensile tine arm holders for strength and dependability.

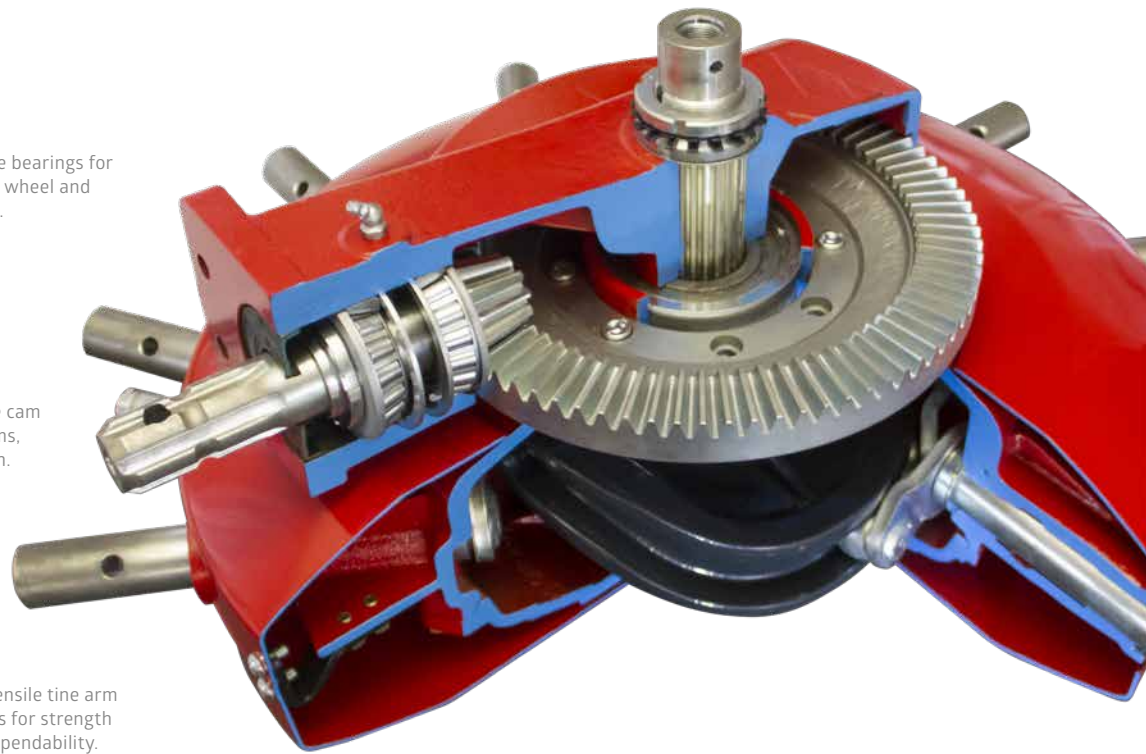

## **Curved Tine Arms**

Correctly adjusting and customizing the rake to the exact conditions facing you today is what adds the extra quality to your forage, ensuring that dirt stays out of the swath, yet leaving no crop behind. Setting the rotor height, adjusting the swath width and fine tuning the cam track (ProLine) is done easily and intuitively on all Andex rakes, taking the hassle out of the daily optimization.

The strong, yet flexible Vicon rake tines accurately move the crop into the swath, and with a wire diameter of up to 10mm they additionally provide the necessary capacity to move even large volumes of crop. The curved tine arms, a true Vicon hallmark, engineered to ensure that the tine arms will leave the swath at exactly the right time, promotes better and more accurate swath formation.

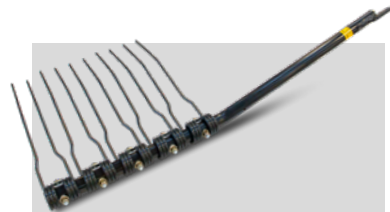

- Higher lifting out of the swath
- Increased capacity
- Faster drying rates due to better formed, more fluffy swaths
- Higher driving speed, as crop is pressed against the tines



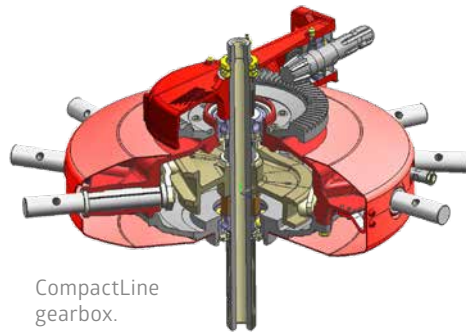

CompactLine gearbox.

**CompactLine**

The Andex CompactLine rakes features oil-immersed cam discs, guide rollers and tine bearings, alleviating maintenance on these components. Strong tine arms and bearings in an oilbath, ensure longevity and easy maintenance. The oil level of the gearbox is easily controlled from the outside.

High-tensile tine arm holders and two bearings on either side of the driveshaft, provide the compact unit with strength and dependability. Vicon-developed cam tracks are specifically manufactured for optimum raking at any working width and on any model.

“**Curved Tine Arms**  
for Perfect Swath Formation”

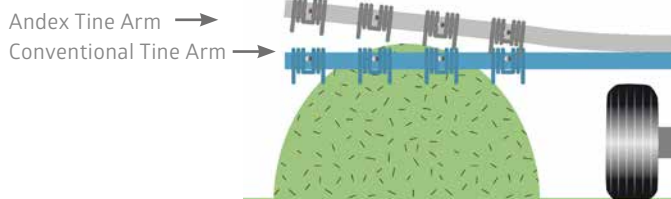

**Curved Tine Arms Supports Regular and Even Swaths**

All Andex rakes are fitted with curved tine arms, to ensure a regular and even swath formation. Additionally the curved shape prevents material from being pushed along the tine inside the rotor to increase capacity.

The specially angled tine arms ensure a higher lift out of the swath and leave the swath at just the exact right time in order to prepare regular and fluffy swaths.



# Stay on Track with TerraLink Quattro

**What really matters is the quality of the silage and hay, which you produce. Precision in every part of the raking process is paramount to ensure that none of the valuable material is left behind, while at the same time securing a clean and attractive crop without dirt.**

### Three-Dimensional Adaptation

The TerraLink Quattro system has become a true legend related to accurate ground following, vital to avoid dirt in the swath - especially in uneven field conditions.

It is a rather simple, yet unique system providing excellent 3-dimensional adaption to ground contours. And it is absolutely maintenance- and wear-free.

### The Strength is in the Arm

The openly constructed frame arm follows the principle of a torsion bar and absorbs vibrations away from the rotor and allows torsion flexibility, adding the extra tracking flexibility and stability of the rotor. Each rotor operates in 3 dimensions to accurately respond and adjust to uneven field conditions.

### High Stability

The trailed wheel axle configuration, where the weight is centered on the front boogie wheels, enhances quiet running and prevents lifting and tine bouncing. Each wheel is positioned as close as possible to the raking tines to ensure highest possible rotor stability, inviting for higher travel speed.

## How TerraLink Quattro Adapts in 3 Dimensions



The rotors are fully flexible in all directions, which means the tines have an exceptional ground following ability....

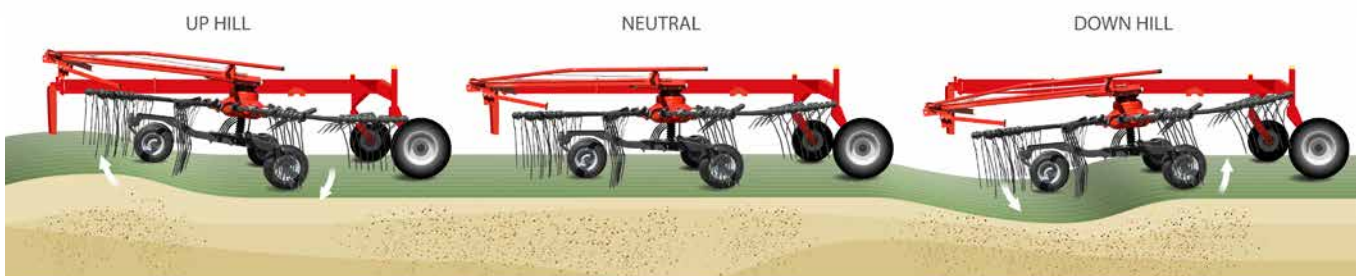

... ensuring a clean raking result without dirt in the crop.





## TerraLink Quattro for Accurate Tracking

Absolutely maintenance- and wear-free.

Unique combination of flexible frame arm and 3-dimensional rotor suspension.

The openly constructed frame arm absorbs vibrations away from the rotor and allows torsion flexibility.

The accurate tracking made possible by the TerraLink Quattro feature, ensures that a minimum of crop is lost during raking.

Rotor operates in 3 dimensions to accurately respond and adjust to uneven field conditions.



The trailed axle configuration enhances quiet running and prevents lifting and tine bouncing and invites for higher travel speed.

The boogie wheels are positioned as close as possible to the raking tines to ensure high rotor stability.

“**Each rotor operates in 3 dimensions**”

## The Real TerraLink Quattro Advantage

The TerraLink system consists of two parts. First the lifting arm and second the undercarrier. The arm is slotted on the downside. This, together with special steel quality, makes it possible for the frame to flex without breaking.





# Overview Rakes *ProLine*



ProLine	DESIGN	
ANDEX 1505	Multi-Rotor Center	
ANDEX 1304 Pro	Multi-Rotor Center	
ANDEX 1304	Multi-Rotor Center	
ANDEX 904 Hydro	Multi-Rotor Center	
ANDEX 844	Multi-Rotor Center	
ANDEX 804	Multi-Rotor Center	
ANDEX 774	Multi-Rotor Side	
ANDEX 464	Single-Rotor Mounted	
ANDEX 424	Single-Rotor Mounted	

## *Comfortable Features on Range Models benefit your Grass Business*









**Vicon Analex 1254**  
Hydraulic lowerable below 4m.



**Vicon Analex 1505**  
Clever folding mechanism for road transport.



	 WORKING WIDTH	 SWATH WIDTH	 ROTOR DIAMETER	 ROTORS	 ARMS / ROTOR	 TINE DIAMETER	 CHASSIS / AXLE
	9.80-15m	1.4-2.5m	3.85m	4 pcs.	13/15 pcs.	10mm	Front cardanic
	10-12.5m	1.2-2.2m	3.35/3.05m	4 pcs.	4x12 pcs.	10mm	TerraLink Quattro
	10-12.5m	1.2-2.2m	3.35/3.05m	4 pcs.	4x12 pcs.	10mm	TerraLink Quattro
	8-9m	1.4-2.4m	3.85m	2 pcs.	2x14 pcs.	10mm	TerraLink Quattro
	7.60-8.40m	1.4-2.1m	3.65m	2 pcs.	2x12 pcs.	10mm	TerraLink Quattro
	7-8m	1.2-2.2m	3.35m	2 pcs.	2x12 pcs.	10mm	TerraLink Quattro
	7.7m	Variable	3.65m	2 pcs.	12/13 pcs.	10mm	TerraLink Quattro
	4.6m		3.65m	1 pcs.	13 pcs.	10mm	Tandem
	4.2m		3.35m	1 pcs.	12 pcs.	10mm	Tandem



**Vicon An dex 1304 Pro**  
Individual lifting feature of all four rotors.



**Vicon An dex 1104**  
ProLine adjustable cam track.

# Overview Rakes

## *CompactLine*









### CompactLine

DESIGN

Model	Design	
ANDEX 1254	Multi-Rotor Center	
ANDEX 764	Multi-Rotor Center	
ANDEX 724 Hydro	Multi-Rotor Center	
ANDEX 724	Multi-Rotor Center	
ANDEX 644	Multi-Rotor Center	
ANDEX 644M	Multi-Rotor Center Mounted	
ANDEX 705 Vario	Multi-Rotor Side	
ANDEX 705 Evo	Multi-Rotor Side	
ANDEX 714T Vario	Multi-Rotor Side Trailed	
ANDEX 714T Evo	Multi-Rotor Side Trailed	
ANDEX 474T	Trailed	
ANDEX 424T	Trailed	
ANDEX 434	Mounted	
ANDEX 394	Mounted	
ANDEX 353	Mounted	
ANDEX 323	Mounted	



	 WORKING WIDTH	 SWATH WIDTH	 ROTOR DIAMETER	 ROTORS	 ARMS / ROTOR	 TINE DIAMETER	 CHASSIS / AXLE
	10-12.5m	1.2-2m	3.05/3.35m	4 pcs.	4x12	9mm	TerraLink Quattro
	7/7.80m	1.2-2m	3.35m	2 pcs.	11	9mm	TerraLink Quattro
	6.2/7.2m	1.2-2.2m	3.00m	2 pcs.	11	9mm	TerraLink Quattro
	6.2/7.2m	1.2-2.2m	3.00m	2 pcs.	11	9mm	TerraLink Quattro
	6.4m	1.2m	3.00m	2 pcs.	10	9mm	Single
	6.4m	1.2m	3.00m	2 pcs.	10	9mm	Single
	6.65/7.85m		3.35/3.23m	2 pcs.	11/12	9mm	TerraLink PLUS
	6.65m		3.35/3.23m	2 pcs.	11/12	9mm	TerraLink PLUS
	6.6/7.1m		2.95m	2 pcs.	11/12	9mm	TerraLink Quattro
	6.6/7.1m		2.95m	2 pcs.	11/12	9mm	TerraLink Quattro
	4.2m		3.65m	1 pcs.	12	9mm	Tandem
	4.2m		3.35m	1 pcs.	11	9mm	Tandem
	4.2m		3.35m	1 pcs.	12	9mm	Single
	3.9m		3.05m	1 pcs.	11	9mm	Single
	3.5m		2.8m	1 pcs.	10	9mm	Single
	3.2m		2.6m	1 pcs.	9	9mm	Single

# ANDEX FOUR ROTOR RAKES



*My way of Farming!*





***ProLine***



**Andex 1505**  
Working Width: 9.8-15.0m



**Andex 1304 (PRO)**  
Working Width: 10.0-12.5m



**Andex 1254**  
Working Width: 10.0-12.5m





## The Only Real 15m *Working Width Machine*

### **15.00m Working Width**

The AnDEX 1505 is designed for high output and heavy use. Four rotors, maintenance-free ProLine gearbox, 15m working width and heavy duty mainframe design underline its' potential as a rake for the most demanding customer segment.

### **The Elbow Design Makes the Difference**

The special elbow design of the front rotor arms is a unique feature of the AnDEX 1505. Raking width can be matched to

differing crop characteristics, to obtain an evenly shaped and equally wide swath across the full width.

The design also allows quick working width adjustment. In case of contact with an obstacle, the overload protection on the outer arm ensures that it folds back at a certain pressure, securing the main frame structure from damages..

Also when raking along borders, the fast moving front arms can

be used to steer along fences etc. without slowing down. Specially while raking corners, it is possible to clean them in one go as the front rotor can be pushed inside the corner.

The biggest benefit with the system though, is that the next swath will still be straight, as the rotor towards the non-raked area stays in position.

When passing obstacles in the field, the front rotors can quickly be moved inwards, ensuring the swaths stays straight.





The unique elbow construction positions the front rotors close to the driver for excellent overview.

### Tackle the Terrain

The front rotors are fitted with hydraulic ground pressure control for constant adjustment of ground pressure. Regardless of chosen working width, ground pressure remains even, allowing the rotor to instantly react to uneven field conditions for accurate tracking. The advantages are obvious, as it leads to less damage and faster regrowth from the stubble and minimum dirt into the crop. Especially in wet conditions the low remaining weight on the rotor is a big advantage in order to get clean crop.

### A Superbly Manoeuvrable Unit

The 2-pt headstock allows a turning angle up to 80° and the optional unique steered wheel axles ensure these Vicon rakes have unequalled manoeuvrability. Despite a total length of 9.20m, even narrow gateways or approach lanes to fields are easily negotiated. For easy headland management it is possible to tailor the sequence of lifting and lowering the front and rear rotors, to optimize the time delay between front and rear rotors. Three different possibilities can be chosen. All 4 rotors can be lifted individually, allowing you to rake any size or shape of field in a professional and efficient way.

### Brakes and Tyres

The wide tires not only ensures gentle treatment of the ground, but also makes for excellent stability both in the field and on the road. Hydraulic or pneumatic brakes permit road speeds up to 40km/h.

All rotors are equipped with 3 twin wheels, 360° free turnable, for perfect guidance and no problem in narrow curves with destroyed grass fields.



Each rotor can be independently and hydraulically set for height. As well a minimum height can be mechanically adjusted to secure a correct setting.



All 4 rotors can be lifted individually.



High lift of rotors ensures generous clearance during headlands turns. Clearance height can be adjusted infinitely.





## Customize the Size *of Your Swath!*

**“***Continuously  
Adjustable  
9.8-15.0m  
Working Width”*

### **Adjustable Working Width**

Raking width can be continuously varied on the move between 9.80m and 15.00m. Raking width can be matched to the density of crop to obtain an evenly shaped and equally wide swath over the full length.

Change of working width can be done in all situations, while driving, but as well while standing still with rotors on the ground. If the width needs to be adjusted shortly, the previously set working width can be recalled automatically.



The two outer rotors can be adjusted individually to match a working width between 9.8-15.0m.



**Everything Under Control with ISOBUS Technology**

The Andex 1505 is fully ISOBUS. This means that it will be plug and play with an ISOBUS compatible tractor without the need for a separate terminal.

The Andex 1505 is available with the IsoMatch Tellus or the IsoMatch Tellus GO control terminals. The IsoMatch Tellus GO is especially developed for controlling machines in a simple way. Just connect your machine, step into the tractor cab, switch on the power button and GO. The terminal brings the implement automatically into view. To maximise user comfort all buttons are positioned on right hand side of the terminal. No need to look at the touchscreen when operating the machine.



BreakBack system.



IsoMatch joystick.



**Take Full Control**

The following functions can be operated with the terminals:

- Swath and working width.
- Programmable lifting height of rotors.
- Automatic selection of transport or working position by pressing an icon.
- Separate lifting of all four rotors.
- Setting of rotor height.
- Adjustment of working width, left and right hand side.
- Active and selectable hydraulic suspension on front rotors.
- Steering of transport axle.
- Headland management activation.
- Adjustment of delay time/meters or manual operation of headland management.
- Special customized user interface, developed with contractors, for very simple control of functions.
- Optional with joystick.



The optional active wheel steering provides excellent manoeuvrability during narrow gateways and tight corners.



With its' clever folding mechanism the total height remains below 4.00m - despite a rotor diameter of 3.85m. And there is no need to remove tine arms for road transport.



## GEORAKE®

# *Simplify your Business*

*With the Vicon GEORAKE® solution, an accurate raking job, with well-shaped swaths, has never been easier. Once headland has been done, all you need to do is control the tractor. As GEORAKE® automatically lifts each rotor at just the right time, the stress factor of finishing swaths correctly, before turning on headlands, or in odd shaped plots is completely eliminated.*

### **GEORAKE® is the Way to Precision**

To maximise output and quality of any raking job skill and precision is needed. Especially during headland operation. All rotors need to be lifted at just the right time, to rake up crop in the most efficient manner and prepare a perfectly formed swath for pick up.

This essential operation has now been fully automated, as each of the four rotors is individually controlled via section control, without any attention needed from the tractor driver.





**Discover this new Opportunities** with the Vicon GEORAKE® solution. An automatic lifting of each rotor at just the right time. Also available with the EXTRA 7100 as GEOMOW®.



As already raked areas are registered, each individual rotor will automatically lift for headland turns and in curvy areas.

#### **GEORAKE® Means Full Support to the Driver**

GEORAKE® registers already raked ground, so once a rotor enters into such an area, it will automatically lift. Each rotor operates individually and acts as one of four sections. When re-entering unraked area, the rotor will automatically lower at just the right time, to ensure complete raking.

“**Smart Raking Starts Here**”

When raking awkwardly shaped fields GEORAKE® avoids raking into already prepared swaths, automatically lifting the rotors involved, without any need for counter steering from the driver. Focus can be kept on driving and a perfect raking result.

No crop is left behind and no headland swaths are destroyed by interference from the rotors. Raking is done with high level of precision.

GEORAKE® is a license based application, and requires machine license and section control license for the Terminal. The Terminal license can as well be used for other operations like planters, spreaders and sprayers.



With GEORAKE® raking is done with high level of precision.

“**Improve Your Raking Performance**”





## Keep Things *Simple*

### **ProLine or CompactLine Specification**

The Andex 12.5m 4-rotor rake is offered with a choice of either ProLine or CompactLine gearbox. Both machines are similar in construction. They are built up on the same frame concept. The Andex 1254 CompactLine version is an easy-to-use machine with substantial working width for the professional segment, looking for a dependable machine to ensure stability in the complete harvesting process.

For heavy duty conditions, the Andex 1304 ProLine machine has been developed.

### **Boost Your Work Day**

Anderson 1254 and 1304 are targeted at making lighter work of tough and demanding operations. Being able to accurately feed the machine that follows and keep up efficiency of the complete harvesting system is an essential part of the raking job. With their impressive capacity of 12.50m working width, straightforward design and possibility to adjust both work and swath width from the cabin, these machines are designed to boost the complete process of collection and pick-up, altering to the changing crop intensity during the season.





**More Uptime with max 4m Transport Height**

No reason for wasting time, not even when moving between fields. Just raise the rotors and off you go, safely below 4.00m transport height – no need to leave the tractor for removing tines arms. Large transport wheels and hydraulic brakes are standard.

For storage all tines arms are detachable on Andex 1254 to allow a storage height as low as 3.40m. A strong and stable storage foot ensures fast and trouble-free coupling and uncoupling.

For Andex 1304 tine arms are generally fixed, but the top 4 are detachable, to reach same low storage height. A free run in the driveline secures that these arms will always be facing upwards.

**“Designed to Boost Capacity”**

Easy and intuitive control function, all handled from the tractor cab.



**Easy Handling – More Output**

Andex 1254 and 1304 are designed with uncomplicated work days in mind. Forget about sophisticated sensors and control functions, they are designed around the operator with simplicity in mind, focusing on the elements that adds real value. Take the control unit for instance.

It comes with a rather handy design including pre-selected functions for an array of easy operations. Only one double and one single acting spool valve are required to run Andex 1254 and 1304.



TerraLink Quattro is a unique combination of flexible frame arm and 3-dimensional rotor suspension.





## An Efficient *Farming System*



Working width can be set hydraulically between 10-12.5m. Swath width is also set hydraulically between 1.2 and 2.2m.

### **Excellent Swath Formation**

To prevent an uneven appearance of the swath and to keep capacity up, the rear rotors are smaller in diameter and turn faster. This secures the additional capacity needed on the rear rotors for the double volume, and as the speed is different it also prevents roping.

The maintenance-free TerraLink Quattro rotor suspension system, operating in 3 dimensions for excellent tracking, works in close combination with the 4 wheeled rotor to ensure high accuracy and stability on slopes. And it is absolutely maintenance- and wear-free.



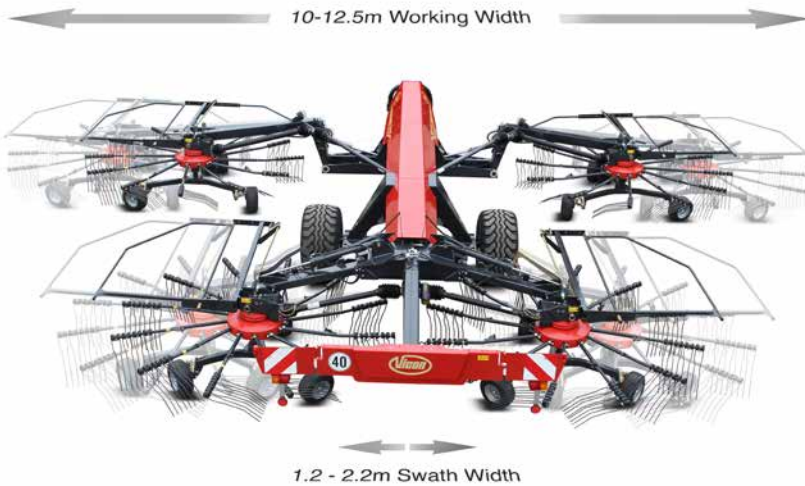

**Hydraulic Adjustment of Working and Swath Width**

The hydraulic adjustment of working and swath width allows you to customize swath intensity and width to the capacity of the following machine. All conveniently handled and controlled from the tractor seat. Working width can be set between 10-12.50m and swath width can be adjusted between 1.20-2.20m, adding the necessary flexibility.

**Easy Headland Management**

These machines come with enhanced headland management. In addition to high ground clearance of rotors during headland turns, it is possible to tailor time delay between lifting/lowering the front and rear rotors to driving speed and field conditions. This is done mechanically in an easy and uncomplicated way.

Andex 1254 and 1304 will do sharp turns of up to 80°, both on headlands and during transport when passing narrow gate ways. The rotors can as a standard feature lift pairwise, convenient for raking crop away from fence lines or when raking low crop fields. Optionally the front rotors can be lifted individually.

**“Compact But Efficient”**

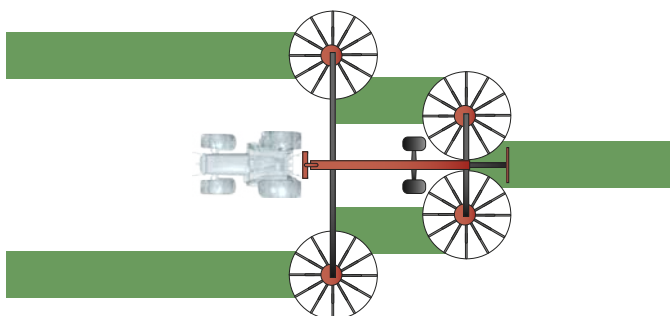

Compact but efficient machine - in combination with BX mower there is the possibility to collect up to 20m into one swath.



Optional tandem axle for additional stability specially on hillside.





## Professional Handling with Andex 1304 Pro – *Maximized Productivity*



### **New four rotor rake with ProLine Set-up**

The Andex 1304 Pro has technical identical details like the Standard Andex 1304. But with the "Pro" Update it comes up with advanced operation possibilities thanks to ISOBUS control. With that add on machine functions can be controlled easily from each ISOBUS ready Terminal as for example Isomatch Tellus PRO or Isomatch Tellus Go. And it supports with further advanced possibilities to adjust and operate the machine.

New functions with ISOBUS:

- Folding and unfolding with just pressing one button
- Working width can be controlled from the terminal
- Possibility to save the swath width
- Different headland delay functions:  
Time/Distance/Manual delay



### Benefits of the 1304 PRO

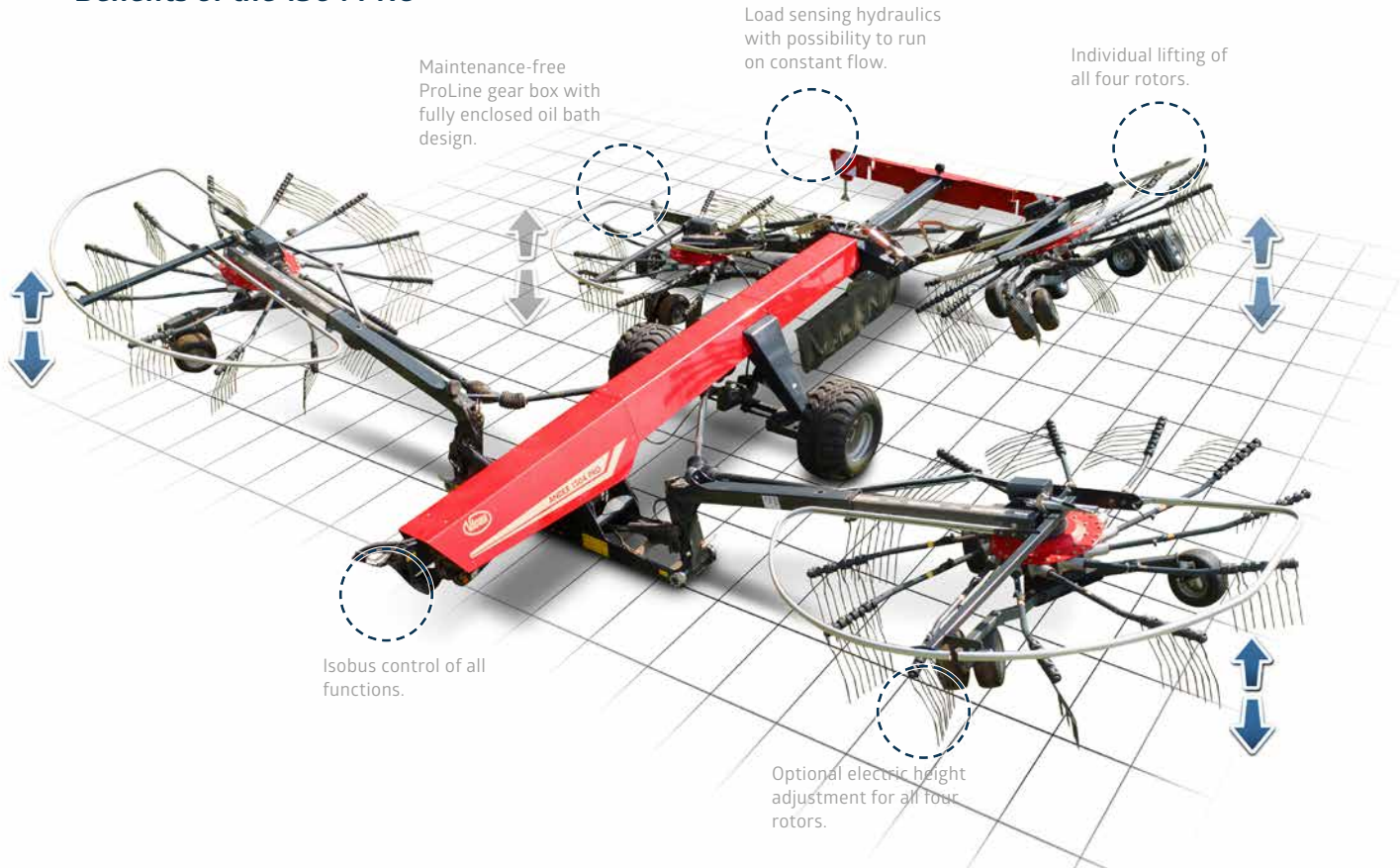

“**Individual lifting of all four rotors** for an efficient and clean raking”



With the individual lifting feature of all four rotors also awkward shaped fields can be raked efficient and clean.



With the electric height adjustment a min and max height is indicated by percentage. It is possible to set an own zero point to get too deep settings visualised by negative values.



Optional three work lights illuminate the critical area in front of the mainframe and one on the end for swath and raking quality.



The high lift of rotors ensures generous clearance during headland turns and will do sharp turns up to 80°.

“**High Ground Clearance** during Headland Turns”



# ANDEX TWO ROTOR RAKES



*My way of Farming!*





**ProLine**



**Andex 804-844-904 Hydro**  
Working Width: 7.0-9.0m



**Andex 774**  
Working Width: 7.7m

**CompactLine**



**Andex 644-644M-724 Hydro -764**  
Working Width: 6.4-7.8m



**Andex 705 Evo/Vario**  
Working Width: 6,65-7,85m  
**Andex 714T Evo/Vario**  
Working Width: 6.6-7.1m





## The Heavy Duty *Centre Swath Rakes*



### **Durable Precision**

With adjustable working widths of 7.00m to 9.00m respectively these heavy duty specification rakes provide the swath formation capability to keep harvesting operations running at their optimum output. At the heart of all models is a heavy duty Pro-Line rotor head system. The machines are equipped with ground protecting 380/55-17 tires.

### **On-the-Go Rotor Height Adjustment**

A ComfortKit is optionally available for Andex 804. This includes a handheld joystick control that brings all control functions into one. The height of each rotor is controlled electronically, and actual height of each rotor is shown on the screen of the control box. In this way fine tuning rotor height, improving your work result is easily done on the go. A screen indicator shows the actual height in percent. It is as

well possible to set a personal zero point, to prevent too deep raking. On top the kit includes individual rotor lifting. It is possible to adjust the rotors together or individual in all positions.

### **Flexible Working Width**

Andex 804:  
7.00-8.00m working width.  
Andex 844:  
7.60-8.40m working width.  
Andex 904 Hydro:  
8.00-9.00m working width.





**Excellent Manoeuvrability**

The rear carrier frame with controlled steering facility gives this rake excellent track following characteristics, allowing tight turns on headlands and loss free swathing even in awkwardly shaped fields. Even if the rotors are lifted on a steep slope, the steering system reliably counteracts any deviation. During headland turns the rotors are lifted up to 45cm from the ground to prevent swath damage.

- Actively steered wheels for excellent tracking.
- Ability to make sharp turns up to 80°.
- High lift of minimum 45cm of rotors ensures generous clearance during headlands turns.
- Single side lift: Raking with only one rotor (standard on Andex 904 Hydro, optional on Andex 804 and 844).



Andex 844 with 8.40m working width, fully enclosed gearbox and hydraulic adjustable working width.

Hydraulic adjustment of working width.



Easy setting of correct raking height.



ComfortKit including electronic control of separate rotor height.



## More Uptime *with Clever Transport Solutions*

### **Analex 804 - Design Optimised for Transport**

The Analex 804 masters both extensive working width and compact transport measures. The new design of the wheel axles allows for the addition of generous 380/55 wheels as standard, whilst still offering a narrow outer track width, making it the perfect match for narrow roads and tight gateways.

Transport height is below 4.00m, even with all tine arms attached. No need to leave the tractor, just fold and go. Add in the 80° turning headstock and active wheel steering, and you have a highly manoeuvrable machine on road and in the field.





With 9.00m working width and transport height below 4.00m, even without detaching tine arms...



... the Andex 904 Hydro offers remarkable productivity with no downtime.

**Andex 904 Hydro - High Capacity in Field, Compact on the Road**

The Andex 904 Hydro will go as wide as 9.00m during work with its´ twin rotors, and offers the flexibility to adjust the working width between 8-9.00m. It will stay below 4.00m during transport, even with all tine arms fully mounted.

Thanks to the hydro axles, which are a unique Vicon feature, the complete rake can be lowered hydraulically for transport, ensuring that it will go

below 4.00m transport height. Another benefit is that the gravity point is moved towards the ground, and in combination with the wide track width and large 380/55-17 tyres it creates excellent weight distribution and stability during transport. Andex 904 Hydro comes as standard with a lift arm suspension and as well with single side lifting.

Standard running wheels of Andex 904 is extra wide 380/55 flotation tyres for excellent ground protection.



The Andex 804 includes a transport height below 4.00m without leaving the tractor cab and actively steered axles supporting tight turns on headlands and during transport.



## Cost-Effective ***Centre Swath Rakes***



*Vicon offers five cost-effective double rotor rakes with strong design. The rakes produce a nice even centre swath from raking widths of between 6.20m and 7.80m. They are mounted on a strong and stable frame to ensure long lifetime. Features such as actively steered wheels, the TerraLink Quattro system and hydraulically working width adjustment are standard - except for the low cost start up model AnDEX 644.*





**Find your Step from Single to Twin Rotor System**

When a single Rotor becomes to small and a two rotor rake is the obvious next size, then the An dex 644/644M is a fitting Entry Model to get more efficiency.

**Unique Manoeuvrability**

The rear carrier frame with controlled steering facility allows tight turns on headlands and loss free swathing even in awkwardly shaped fields. This gives ability to make sharp turns up to 80°.



Active wheel steering and sharp turns up to 80°.

**“Strong Frame  
Ensure Long  
Lifetime”**



Height of the carrier frame offers outstanding ground clearance on headlands.





## Compact Design – *High Performance*



The hydraulic adjustable rotors can be set between 7.00m...



...and 7.80m working width on An dex 764.

### **An dex 724 and 764**

Both An dex double rotor rakes offer hydraulically adjustable working width. This enables varying the swath width from 1.20-2.20m, ensuring a perfect match to the pick-up width of loader wagons, balers and foragers.



**Andex 724 Hydro - Resetting the Standard**

The Andex 724 Hydro is fitted with hydraulically operated axles on the mainframe, in order to lift and lower the machine during transport and operation. This feature significantly reduces transport height by 40cm, allowing a transport height as low as 3.45m.



Lifting the machine.



Lowering the machine.

Add in features such as adjustable working width of 6.2-7.2m, TerraLink Quattro ground contour following and heavy duty carrier frame design, and the result is low maintenance, higher productivity and maximum operation comfort.

As well the CompactLine gearbox, with all critical parts running in oil, helps to reduce maintenance time to a minimum.

All main functions, such as lifting and lowering of mainframe and rotors are operated from the tractor cab, using an electro hydraulic control terminal.

It is also possible to pre-select lift activation of the rotor units via the terminal. Such an integrated solution is offered only by Vicon.

**“Higher Productivity – Maximum Operator Comfort”**



Vicon centre swath rakes are converted hydraulically for transport from the tractor cab.



To limit transport height further the tine arms can be removed on the Andex 764. The swath board is folding up automatically.



The Andex multirotor rakes are fitted with TerraLink Quattro for excellent raking. Except for Andex 644.





## High Manoeuvrability *for Narrow Roads and Awkward Fields*



Compact transport position.

### **Andex 644M – Comfortable Dimensions**

The new compact Andex 644M shows with its compact mounted design in combination with the three point linkage high manoeuvrability for narrow roads and tight gateways. The mounting makes the Andex 644M then an ideal fit for mastering smaller and awkwardly shaped fields.

With its working width of 6.4m and 3.05m rotor diameter, it is suitable for raking 2x 3.2m mower swaths into one row.



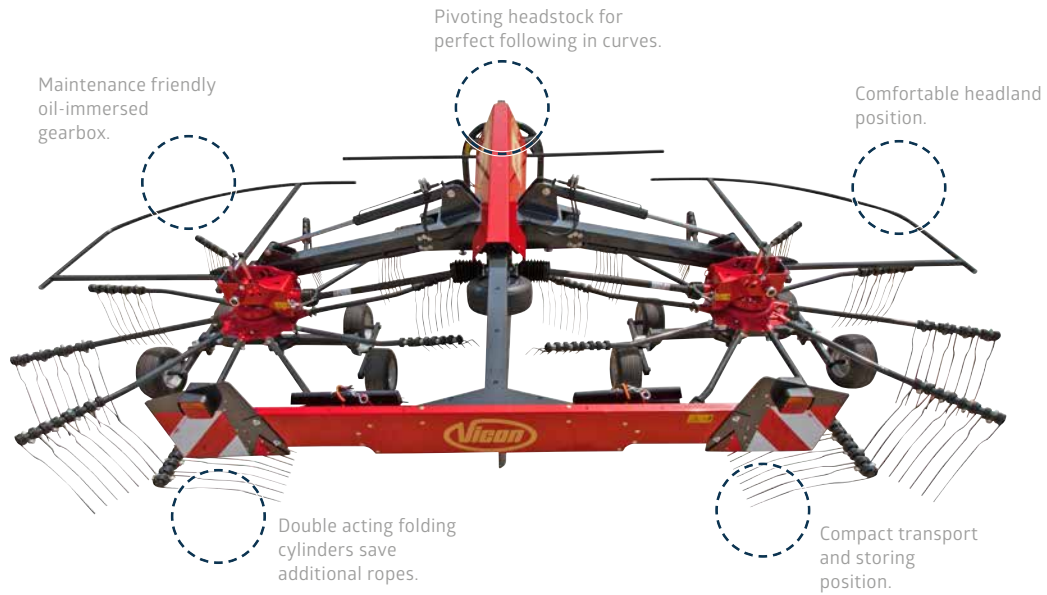

**The AnDEX 644M is set-up with simple technology:**

- No ropes for transport locks.
- Only two positions, folded or unfolded (double acting cylinders).
- No mistakes while operating.
- No need to operate with hydraulic valve during work.
- Easy headland lift with 3 point linkage.
- Outstanding clearance in headland position.
- Pivoting headstock to guide the machine freely along the field contour.
- Fixed wheels can be used.
- Together with stabilizers, a perfect performance also on hillside is guaranteed.
- Optional tandem wheels can even create a softer performing.



Tandem axle (optional).



Height adjustment.



Narrow and short transport position without leaving the cabin.



More flexibility by parking as no tine arms need to be detached.



Better ground adaptation compare to larger single rotor rakes.



High flexibility on the road, and in the field, as no carrier is disturbing.





Vicon AnDEX 774.

## Double Up *on Efficiency*



*The AnDEX 774 double rotor rake delivers a working width of 7.70m. The side delivery concept adds excellent flexibility in swath formation and allows you to collect crop from a working width of up to 15.00m into one swath. The high build mainframe concept offers excellent ground clearance in headland position. Actively steered wheels allow sharp turning, both on headlands and during transport.*





A hydraulic foldable swathboard is optionally available for AnDEX 774.



Active wheel steering for improved manoeuvrability in combination with large wheels for reduced compaction.



The side delivery concept allows you to collect crop from 15.00m into a single swath.

“**Accurate  
Raking  
Performance**”

#### Exceptional Manoeuvrability

AnDEX 774 is fitted with the renowned Vicon ProLine gearbox, with its' maintenance free oilbath solution. The shape of the Vicon hallmark, the massive 400mm curve disc, allows the tine arms to leave the crop faster, leaving a more uniform swath shape.

In addition the rotors have been upgraded to 12 tine arms on the front rotor, each with 4 tines, and 13 tine arms, each with 5 tines on the rear rotor. This ensures more accurate raking performance, without roping, and allowing higher forward speed.

Vicon side delivery rakes have steerable undercarriers on the front rotor to secure a smooth following in curves. As well a swath board on the first rotor stops the crop, so it can be picked up by the rear rotor (Option on AnDEX 705 Evo).

In addition AnDEX 774 is fitted with the Vicon TerraLink Quattro wheel system for superb ground contour followings. This system controls the rotor in 3 dimensions.



Vicon AnDEX 705 Vario.

## Side Delivery Rakes – *Proactive Performance*



The Touch-Down-Effect, comparable to an airplane's approach angle of its landing chassis, ensures a smooth and clean raking, but also avoids with lifting to a ground clearance of around 500 mm that swaths on headlands are being damaged.

### **The NEW! AnDEX 705 Side Delivery Rake**

The new Vicon AnDEX 705 Evo + Vario, a carried side delivery rake, delivers *flexibility* in raking, more *comfort* in operating and higher *quality* of forage due to the new TerraLink Plus cardanic rotor attachment.

### **Higher Quality of Forage**

With the updated feature "Terralink PLUS", the cardanic rotor attachment benefits with a further advanced ground adaptation of 8°.

On top it is supported by the Touch-Down-Effect. The TerraLink Plus cardanic secure less dirt in the crop and a more smooth running. Due to this forage quality increase, further the milk yield and health of the animals increase. To keep also the grassland in a good shape the machine is standard equipped with 380mm ground protecting wheels.





Maintenance-friendly CompactLine gearbox with fully enclosed oil bath design.

Vario Model. Possibility to do "two" swath. One large single swath or two smaller night swaths.

Automate folding of swath board by gravity without hydraulic control.

Terralink PLUS stands for a cardanic rotor attachment that benefits with a further advanced ground adaptation supported by the "Touch-Down-Effect".

New steering geometry allows more narrow turns than previous model with close to 80° steering angle. Ground clearance in headland position > 500 mm.

Optional tandem axles available. steered for front and fixed for rear rotor.



Vario two swathing.

**Flexibility in Raking:**

- unique rotor set up with a smaller rotor in the rear in combination with one tine arm more secures a perfect swath under all conditions
- improved steering geometry
- steered tandem axles on the front and fixed on the rear ensure a smooth running also in difficult conditions
- perfect view towards left side of swath distribution
- automatic swath forming
- Vario enables to place two swaths, either for small balers in high crop volume or for night swaths to increase hay quality



Automatic fold-able swath board with parking stand.



Tandem wheels (optional).



Transport height below 4.0m.



Hydraulic transport locking (optional).

**More Comfort in Operation is delivered by:**

- comfortable connecting of the machine
- automatic folding of the swath board
- optional hydraulic transport locking
- improved steering that gives you better maneuverability in the field
- options like tandem axles support customizing the machine for individual requirements



Ground clearance >500mm.



## The Flexible Raking *Solution*



### **Flexible Raking**

The AnDEX 714T Vario and 714T Evo are designed for maximum flexibility for raking in different conditions. The twin rotors, working independently from each other, makes it possible to collect either one large swath or two smaller swaths.

Alternatively the rakes can place two large swaths into one, allowing a total of up to 12.50m crop to be gathered into one.

### **Vicon SideShift**

The Vario version also offers the patented SideShift system as an option, which comprises electro-hydraulic control of all functions. SideShift offers the possibility to side shift both rotors - both front and the rear - from the tractor cab. With this patented system, raking along field boundaries or around trees is no problem - as the tractor can run at a safe distance from the obstacles. It is also possible to drive with the tractor on already raked ground.





“**Electro-Hydraulic Control of All Functions**”



The 714T Vario with 7.10m working width and unique SideShift device.



SideShift to the right - conveniently passing trees.



SideShift to the left - raking without driving on unraked crop.

**Easy Conversion from Working to Transport Configuration**

There is no need to remove tine arms: moving the AnDEX 714T Vario and 714T Evo to transport position only requires a simple operation on the control unit. The swath deflector is lifted hydraulically and transport width for AnDEX 714T Vario and 714T Evo is only 3.00m (to reach 2.45m, the tine arms can be removed).



With 50cm lifting height, swaths can be driven over with no problem at all. Rotors are lifted using only a single acting valve.

The machine comes as Evo standard with tandem axle in the front. As Vario the machine is equipped as well with a land wheel standard (option for EVO) Optional the machine can be equipped with up to 13 wheels with tandem axle on the rear rotor and two sets of inner tandem axles on the front of the undercarrier

11 arms in the front and 12 arms in the rear secure a even swath and good crop flow, and prevents roping.



Both rakes are capable of placing small neat swaths for hay crops.



AnDEX 714T Evo/Vario in transport.



# ANDEX SINGLE ROTOR RAKES

*My way of Farming!*







**ProLine**



**Andex 424-464**  
Working Width: 4.2-4.6m

**CompactLine**



**Andex 323-353-394-434**  
Working Width: 3.2-4.3m



**Andex 424T-474T**  
Working Width: 4.2-4.7m





## Built-In *Reliability*



Tine arms can be easily removed.

### **High Performance**

Vicon's ProLine single rotor rakes offer a gearbox design with excellent working result. Features such as oscillation dampers, tandem axles and HydroLift height adjustment are standard hallmarks of the single rotor rakes.

### **HydroLift Concept**

A unique Vicon feature of the AnDEX 424 and 464 is the standard HydroLift concept. It is a hydraulic height adjustment system that allows the driver to quickly adjust working height to different ground conditions from the tractor cab as well including the possibility to mechanically set a minimum height.





For transport or storage, the rotor guard frames are folded up close to the mainframe, locking automatically into position. An assister spring linked to the swath board reduces the effort required.

**ProLine Gearbox**

The Andex single rotor rakes are based on the ProLine gearbox technology. These machines offer working widths of 4.20m and 4.60m respectively and are fitted with the renowned Vicon ProLine gearbox, with its' maintenance-free oilbath solution.

The shape of the Vicon hallmark, the massive 400mm curve disc, has been improved to allow the tine arms to leave the crop faster, leaving a more uniform swath shape.

Both rakes are standard fitted with both 4 wheel tandem axles and oscillation dampers, offering excellent ground contour following, minimizing the amount of dirt collected in the swath.



Oscillation dampers ensure excellent running characteristics.



As an option these rakes can be supplied with a third wheel, to ensure even better flotation.



Infinitely variable cam track adjustment allows fine tuning, to obtain optimum raking and swath formation according to crop conditions.

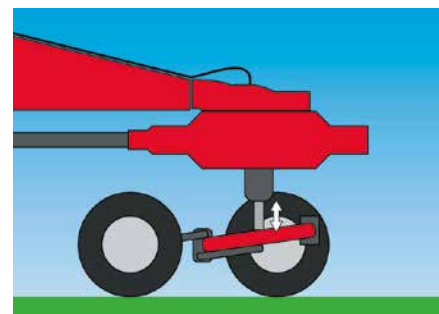

HydroLift height adjustment also offers the possibility to set a minimum height.





## Compact Design – *Low Maintenance*

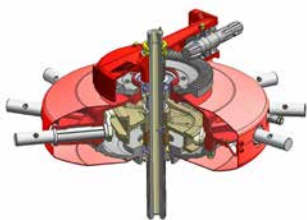

Compact design for easy maintenance.

### **The Compact Range**

For smaller raking operations, Vicon offers several models designed for use on lower horsepower tractors, whilst delivering similar raking performance compared to its' higher specification machines. With the pivoting three point linkage machines and also a trailed versions, there is a model to suit any need, from lowland farmers, to the users working on steep hillsides.

### **Index 'Compact' Rotor Head**

The rotor head is grease lubricated. Within a fully enclosed housing, the maintenance-free cam track and cam followers are running permanently lubricated in an oilbath. The rotor shaft and pinion shaft are all mounted on two bearings for maximum strength and long service life.





The Andex 394 with 3.90m working width for fast and effective raking action. Also perfect for turning straw swaths.

**Curved Tine Arms**

All Andex CompactLine rakes feature cranked tine arms for significantly cleaner raking performance and optimised swath formation. This design ensures that the row of tines on each tine bar has a more effective approach angle to the oncoming crop, and also gives a cleaner lift out of the tine from the formed swath.

As an option these rakes can be supplied with a third wheel, to ensure even better flotation.



The Andex 353 with 3.50m working width offers high performance with a simple, but reliable system.



All rakes can be set for reduced transport and storage width by removing the tine arms and placing them on the carrier frame.



A pivoting 3-pt headstock ensures perfect ground following performance, and perfect tracking when cornering. Oscillation dampers are optionally available.



Andex 474T – 4.70m working width and a weight of only 665kg.



With a linkage mounted drawbar, the Andex 474T can be easily operated by low horse power tractors.



The machine can conveniently be raised up to a height of 50cm from the tractor driver's seat.



## Original Parts & Service

***We are here so you can focus on your crop***

- 
- 1 Long lasting, high quality spare parts**
  - 2 Over 100 years of parts knowledge**
  - 3 Support from a wide network of dealers**
  - 4 24/7 spare parts service**
  - 5 Highly skilled dealer technicians**





“**MYVICON**  
Connected farming, my way”

**A personalised online platform tailored to your machine needs**

With MYVICON you will benefit from easy access to Vicon's online service tools. Receive first hand access to information on future developments and updates, operator and spare part manuals, FAQs and local VIP offers. All information is gathered in one place.



**REGISTER YOUR PRODUCT NOW:  
MY.VICON.EU**



# Facts

Model Index	Single Rotor Rakes								Double Rotor Rakes		
	323	353	394	424	424T	434	464	474T	644	644 M	705 Vario
<b>Dimensions &amp; Weights</b>											
Working width (m)	3.20	3.50	3.90	4.20	4.20	4.30	4.60	4.70	6.40	6.40	6.65/ 7.85
Working width (ft)	(10'6")	(11'6")	(12'10")	(13'9")	(13'9")	(14'1")	(15'1")	(15'5")	(20'10")	(20'10")	(21'8"/ 25'8")
Transport width (m)	1.60	1.75	1.75	1.75	2.00	2.10	2.15	2.40	2.80	2.85	2.80
Transport width (ft)	(5'3")	(5'8")	(5'8")	(5'8")	(6'6")	(6'9")	(7'1")	(7'9")	(9'2")	(9'3")	(9'2")
Transport length (m)	3.10	3.35	3.60	3.15	3.90	3.85	3.35	4.80	5.90	3.85	8.65
Transport length (ft)	(10'2")	(10'12")	(11'10")	(10'4")	(12'10")	(12'7")	(11')	(15'9")	(19'4")	(12'6")	(28'4")
Parking height (m)	1.60	1.70	1.85	2.60	2.30	2.00	2.75	2.65	3.85	3.81	3.5**/ 3.99
Parking height (ft)	(5'3")	(5'6")	(6'1")	(8'6")	(7'6")	(6'6")	(9'0")	(8'7")	(12'7")	(12'5")	(11'5"/ 13'1")
Weight (kg)	315	420	460	640	570	480	670	665	1510	1200	2240
Weight (lb)	(694)	(926)	(1014)	(1410)	(1256)	(1058)	(1477)	(1466)	(3329)	(2646)	(4938)
Swath width (m)	-	-	-	-	-	-	-	-	1.20	1.20	-
Swath width (ft)	-	-	-	-	-	-	-	-	(3'11")	(3'11")	-
Capacity theo. (ha/h)	3.5	3.9	4.3	4.6	4.6	4.7	5.1	5.2	6.9	6.9	7.6/8.7
<b>Hitching system</b>											
Pivoting 3-pt headstock (cat.)	1/2	1/2	1/2	2	-	1/2	2	-	-	-	-
Lower links (2-pt.)	-	-	-	-	-	-	-	-	●	●	●
Linkage drawbar	-	-	-	-	●	-	-	●	-	-	-
Gauge wheel 16"	0	0	0	0	0	0	0	0	-	-	-
<b>Rotors/Tine arms/Tines</b>											
Rotor diameter (m)	2.60	2.80	3.05	3.35	3.35	3.35	3.65	3.65	3.00	3.05	3.35/ 3.23
Rotor diameter (ft)	(8'6")	(9'2")	(10')	(11')	(11')	(11')	(12')	(12')	(9'9")	(10')	(11')
Swath delivery	left	left	left	left	left	left	left	left	centre	centre	left
Number of rotors	1	1	1	1	1	1	1	1	2	2	2
Number of arms per rotor	9	10	11	12	11	12	13	12	10	10	11/12
Number of double tines/ arm	3	4	4	4	4	4	4	4	4	4	4
Tine diameter (mm)	9	9	9	10	9	9	10	9	9	9	9
Adjustable cam track	-	-	-	●	-	-	●	-	-	-	-
Detachable tine arms/rotor	●	●	●	●	●	●	●	●	-	-	●
Height adjustment	rack trail	mech.	mech.	hydr.	mech.	mech.	hydr.	mech.	mech.	mech.	mech.
<b>Wheels and axles</b>											
Tyre (rotors)	15x 6.00-6	16x 6.50-6	16x 6.50-6	16x 6.50-6	18x 8.50-8	16x 6.50-6	16x 6.50-6	18x 8.50-8	16x 6.50-6	16x 6.50-6	16x 6.50-6
Fixed tandem axle	0	0	0	●	●	0	●	●	0	0	-
Pivoting tandem axle	-	-	-	0	-	-	0	-	-	-	-
Stand. tyres (carrying frame)	-	-	-	-	-	-	-	-	10.0/ 75-15.3	-	380/ 55-17
Opt. tyres (carrying frame)	-	-	-	-	-	-	-	-	-	-	-
<b>Optional Equipment</b>											
Lift arm susp./stabilisation	0	0	0	●	-	0	●	-	-	-	-
Locking catch for slopes	0	0	0	●	-	0	●	-	-	-	-
<b>Safety accessories</b>											
Warning panels	0	0	0	0	0	0	0	0	●	●	●
Road lights	0	0	0	0	0	0	0	0	●	●	●

● Standard 0 Optional - Not available \* Double swath \*\* With detached tine arms \*\*\* Hydraulically lowered main frame

Information provided in this brochure is made for general information purposes only and for worldwide circulation. Inaccuracies, errors or omissions may occur and the information may thus not constitute basis for any legal claim against Kverneland Group. Availability of models, specifications and optional equipment may differ from country to country. Please consult your local dealer. Kverneland Group reserves the right at any time to make changes to the design or specifications shown or described, to add or remove features, without any notice or obligations.

Four Rotor Rakes													
705 Evo	714T Vario	714T Evo	724	724 Hydro	764	774	804	844	904 Hydro	1254	1304	1304 Pro	1505
6,65	6.60/ 7.10*	6.60/ 7.10*	6.20/ 7.20	6.20- 7.20	7.00/ 7.80	7.70	7.00- 8.00	7.60- 8.40	8.00- 9.00	10.00- 12.50	10.00- 12.50	10.00- 12.50	9.80- 15.00
(21'8")	(21'8"/ 23.4")	(21'8"/ 23.4")	(20'4"/ 23'7")	(20'4"/ 23'7")	(23'/ 25'7")	(25'3")	(23'- 26'30")	(24'11"- 27'7")	(26'3"- 29'6")	(32'10"- 41')	(32'10"- 41')	(32'10"- 41')	(32'2"- 49'3")
2.80	2.20**/ 3.00	2.20**/ 3.00	2.80	2.80	2.80	2.85	2.80	2.98	2.98	2.99	2.99	2.99	2.99
(9'2")	(7'3***/ 9'10")	(7'3*/ 9'10")	(9'2")	(9'2")	(9'2")	(9'3")	(9'2")	(9'8")	(9'8")	(9'8")	(9'8")	(9'8")	(9'8")
8.65	7.40**/ 8.20	7.40**/ 8.20	5.90	5.90	5.90	8.90	5.95	6.25	6.25	8.75	8.75	8.75	9.85
(28'4")	(24'3***/ 26'11")	(24'3***/ 26'11")	(19'4")	(19'4")	(19'4")	(29'2")	(19'52")	(20'6")	(20'6")	(28'8")	(28'8")	(28'8")	(32'4")
3.5**/ 3.99	-	-	3.85	3.45***/ 3.95	3.45**/ 4.10	3.70**/ 4.10	3.41/ 3.90	3.45**/ 4.10	3.50**/ 3.98	3.45/ 3.99	3.45/ 3.99	3.45/ 3.99	3.45**/ 4.00
(11.5"/ 13'1")	-	-	(12'7")	(11'3"/ 13")	(11'3"/ 13'5")	(10'6"/ 13'5")	(11'2"/ 12'10")	(11'3"/ 13'5")	(11'6"/ 13'1")	(11'3"/ 13'1")	(11'3"/ 13'1")	(11'3"/ 13'1")	(11'3"/ 13'1")
2300 (5071)	1400 (3086)	1350 (2976)	1640 (3615)	1680 (3704)	1640 (3615)	2160 (4762)	2065 (4553)	2285 (5038)	2350 (5181)	4300 (9480)	4700 (10362)	4700 (10362)	6000 (13228)
-	-	-	1.20- 2.20	1.20- 1.90	1.30- 1.90	-	1.20- 2.20	1.40- 2.10	1.40- 2.40	1.20- 2.20	1.20- 2.20	1.20- 2.20	1.40- 2.50
-	-	-	(3'11"- 7'3")	(3'11"- 6'3")	(4'3"- 6'3")	-	(3'11"- 7'3")	(4'7"- 6'11")	(4'7"- 7'10")	(3'11"- 7'3")	(3'11"- 7'3")	(3'11"- 7'3")	(4'7"- 8'2")
7.6	7.3	7.3	7.5	7.5	8.4	8.5	8.8	9.2	9.9	13.8	13.8	13.8	16.5
-	-	-	-	-	-	-	-	-	-	-	-	-	-
●	-	-	●	●	●	●	●	●	●	●	●	●	●
-	●	●	-	-	-	-	-	-	-	-	-	-	-
-	●	0	-	-	-	-	-	-	-	-	-	-	-
3.35/ 3.23	2.95	2.95	3.00	3.00	3.35	3.65	3.35	3.65	3.85	3.05/ 3.35	3.05/ 3.35	3.05/ 3.35	3.85
(11)	(9'6")	(9'6")	(9'10")	(9'10")	(11')	(11'12')	(11')	(12')	(12'7")	(10'/11')	(10'/11')	(10'/11')	(12'7")
left	left	left	centre	centre	centre	left	centre	centre	centre	centre	centre	centre	centre
2	2	2	2	2	2	2	2	2	2	4	4	4	4
11/12	11/12	11/12	11	11	11	12/13	2x12	2x12	2x14	4x12	4x12	4x12	13/15
4	4	4	4	4	4	4/5	4	4	4	4	4	4	4/5
9	9	9	9	9	9	10	10	10	10	9	10	10	10
-	-	-	-	-	-	-	●	●	●	-	●	●	●
●	●	●	-	-	●	●	(4)	●	(4)	●	(4)	(4)	(4)
mech.	mech.	mech.	mech.	mech.	mech.	mech.	mech./ opt. hydr.	mech.	opt - el.	mech.	mech.	mech./ opt. hydr.	hydr.
16x 6.50-6	18.5x 8.50-8	18.5x 8.50-8	16x 6.50-6	16x 6.50-6	16x 6.50-6	16x 6.50-6	16x 6.50-6	16x 6.50-6	16x 6.50-6	16x 6.50-6	16x 6.50-6	16x 6.50-6	16x 6.50-6
-	0	0	0	0	0	-	0	0	0	-	-	-	Terra
-	-	-	-	-	-	-	-	-	-	0	0	0	Contact
380/ 55-17	-	-	10.0/ 75-15.3	10.0/ 75-15.3	10.0/ 75-15.3	380/ 55-17	380/ 55-17	380/ 55-17	380/ 55-17	500/ 50-17	500/ 50-17	500/ 50-17	560/ 60-22.5
-	-	-	-	-	-	-	-	-	-	-	-	-	-
-	-	-	-	-	-	-	-	0	●	0	0	0	●
-	-	-	-	-	-	-	-	-	-	-	-	-	-
●	●	●	●	●	●	●	●	●	●	●	●	●	●
●	●	●	●	●	●	●	●	●	●	●	●	●	●

Safety devices may have been removed from the machines for illustration purposes only, in order to better present functions of the machines. To avoid risk of injury, safety devices must never be removed. If removal of safety devices is necessary, e.g. for maintenance purposes, please contact proper assistance or supervision of a technical assistant. ® = trade mark protection in the EU. © Kverneland Group Kerteminde AS



# Proud History of Ground Breaking Innovations

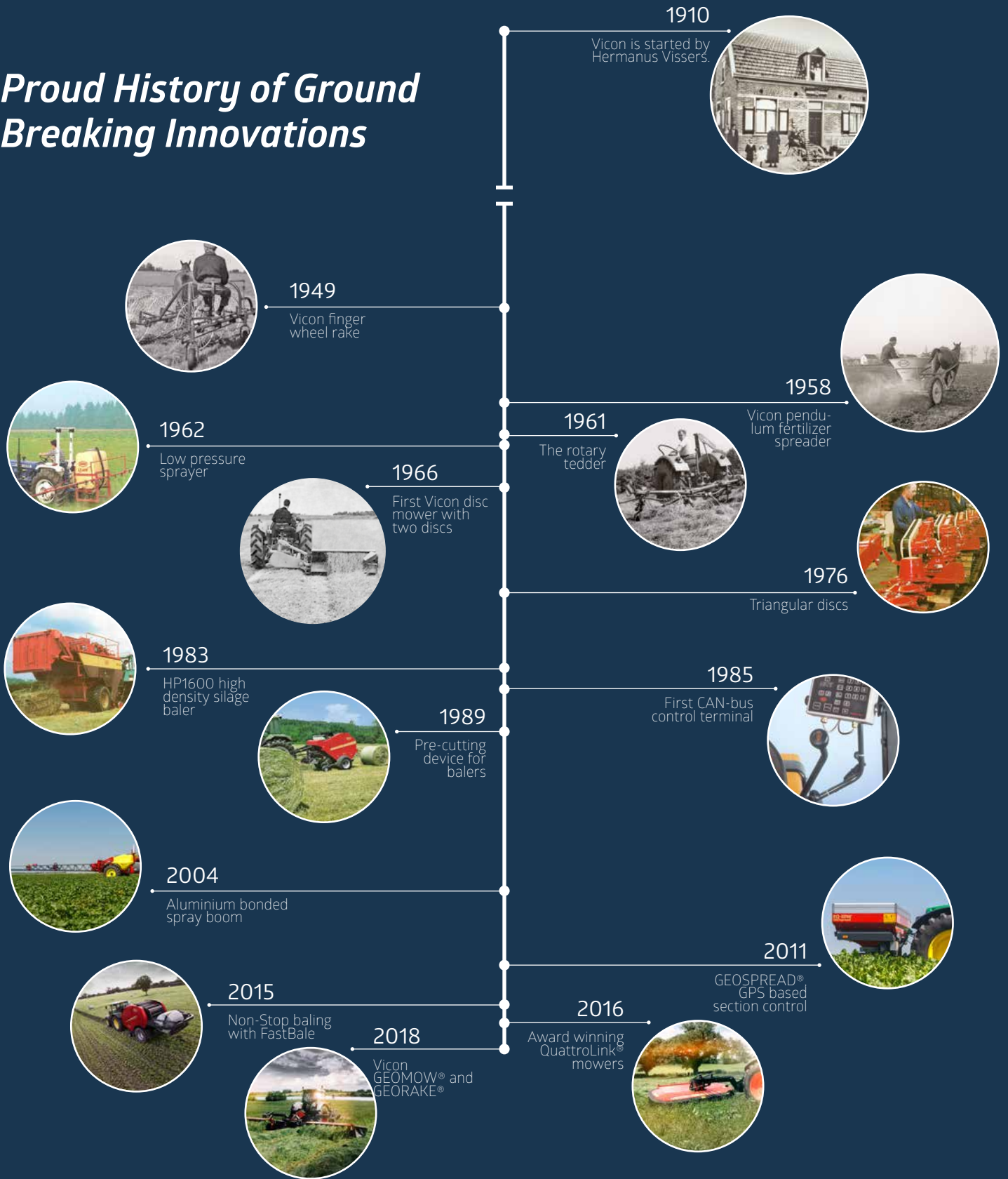

*My way of Farming!*



www.vicon.eu