

Rotary Tedders
Four, Six, Eight, Ten



Fanex Rotary Tedders



My way of Farming!



KEEP YOUR PRODUCTIVITY RUNNING

My way of Farming!



Working the land, running my farm and connecting with nature. Farming is my way of living, and despite being rough at times, I never grow weary of everyday tasks of attending to my land and livestock. I keep up with developments by staying loyal to personal philosophies and applying the appropriate strategy.

I shape and influence my own future by combining craftsmanship with modern technology, employing the very best machinery. I actively seek new opportunities, by being innovative in my way of working. I work hard to grow a good crop. I am passionate about my livestock, providing my animals with only the best. My farm and its returns, reflects who I am, because my heart and soul is put into the work I do.

Farming is about passion, about growing and developing, my crop, my farm, myself, my way.

CompactLine **Models**

Mounted Tedders



Vicon Fanex 464-524

Compact tedders with low maintenance.
Working width of 4.6-5.2m.



Vicon Fanex 604-804

Compact tedders - ideal for hay making.
Working width of 6.05-8.05m.

ProLine *Models*

3-Point Mounted Tedders



Fanex 554-684-764-904-1124

New Generation of heavy duty mounted tedders - strong driveline - compact transport dimensions. Working width of 5.5, 6.8, 7.6, 9.0 and 11.2m.

Semi-Mounted Tedders



Vicon Fanex 904C-1124C

Mounted tedders with transport running gear. Working width of 9m.

Carrier Frame Tedders



Vicon Fanex 1404C

Carrier frame tedder. Working width of 13.3m.

CompactLine - Maintenance-Friendly Gearbox

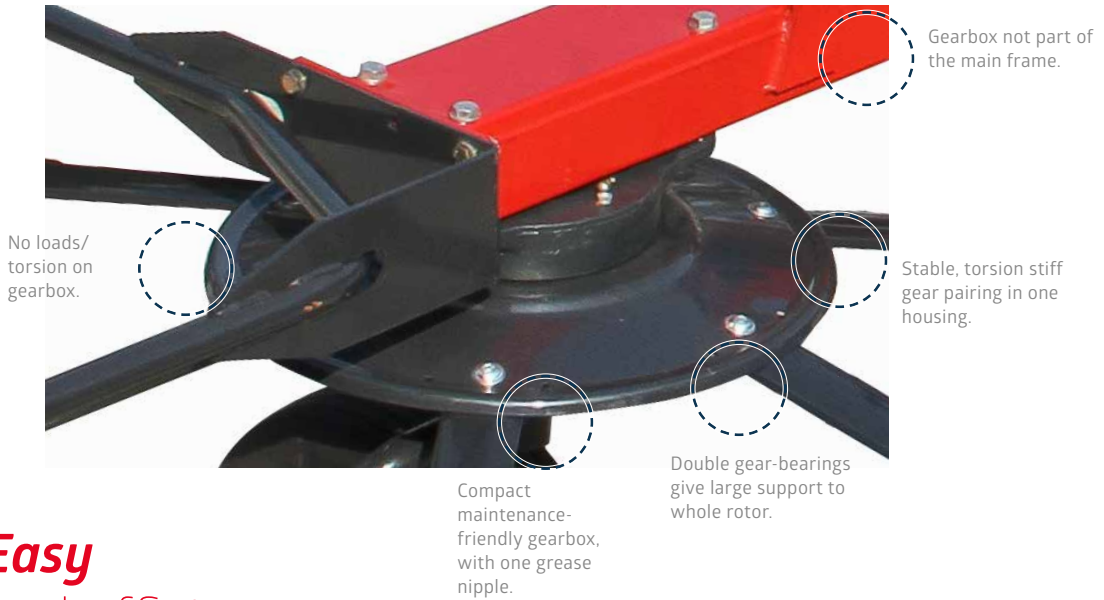

“**Easy**
and efficient
Set-up”

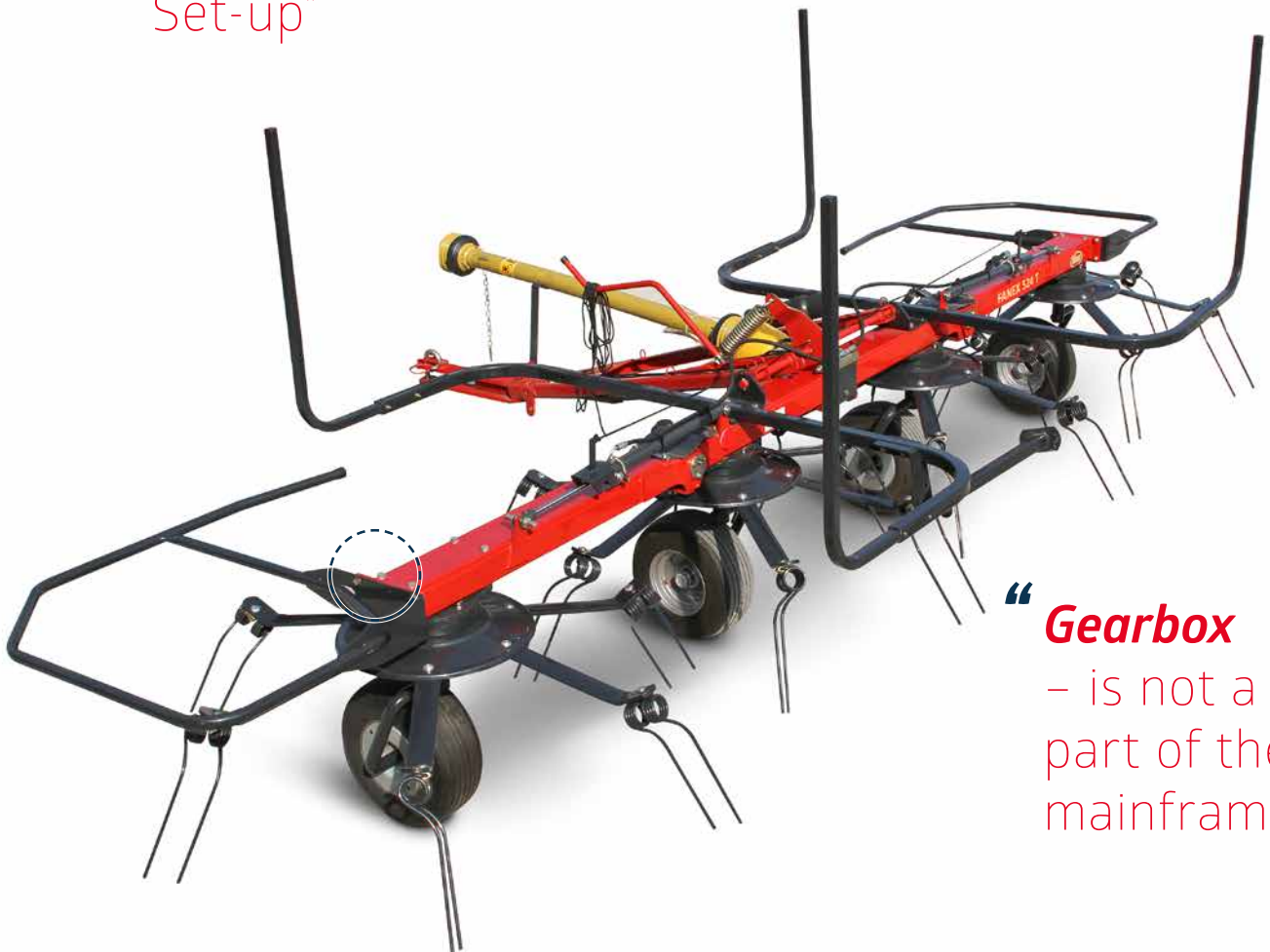

ProLine - Maintenance-Free Gearbox

“No maintenance of the gearbox required – permanent oilbath lubrication”

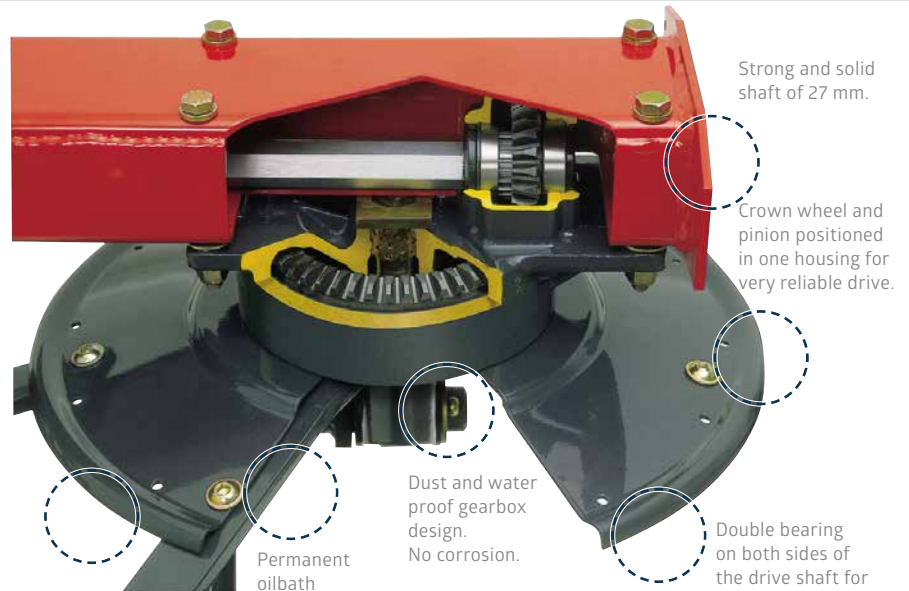

Gearbox does not serve as part of the mainframe, but is bolted on. No strain is transmitted to the gearbox.

Permanent oilbath lubrication – no maintenance of the gearbox required.

Dust and water proof gearbox design. No corrosion.

Double bearing on both sides of the drive shaft for highest durability to withstand the most severe conditions.

A Strong Reliable Heart

Vicon ProLine tedders feature a uniquely designed self-contained rotor gearbox. The ProLine gearbox requires no maintenance, and is situated in an enclosed oilbath, set up to ensure permanent lubrication. No service or maintenance of the ProLine gearbox is needed.

The gearboxes do not serve as part of the frame, but are bolted onto the fully welded mainframe. This ensures that no load and strain from frame will be transmitted by the gearbox, adding to significantly longer lifetime.

The ProLine gearboxes feature reliable crown and pinion drives positioned in one housing. The main crown wheel in each gearbox is mounted directly to the casing by means of double bearing. The double bearings on both sides of the hexagonal drive shaft keeps the shaft securely in place, even when operating in heavy duty wet crop.

Heavy Duty Mainframe Design

The Vicon tedders are built around a rugged new box section mainframe, made out of one piece of metal with only one welding seam – for maximum rigidity. The frame design is fully enclosed at the top edge for maximum strength – an exceptionally solid design, which allows the Vicon tedders to withstand the most severe loads.

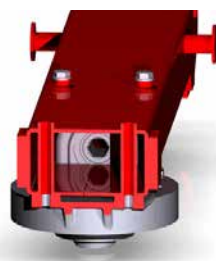

The large drive shafts and double U-joints give smooth, efficient transfer of power through the frame allowing each rotor to accurately follow field contours.



Maintenance-free roller bearing for best possible performance and higher second hand value.



*only ProLine

ProLine Super-C Tines – Even Spread, *Clean Job*



Super-C tine with symmetric spring tines ensure efficient pick-up and turning of the crop. Tines with same lengths has the added advantage that load is spread evenly on both tines, providing longer lifetime.*

Made from flat steel, the tine arms form a very compact unit with the rotor plate and utilize the force of the rotor plate for higher durability of the tine arm. This makes a Fanex tine arm by far more resistant to any type of load.

The Super-C tine can be locked in three positions to customize the pick-up angle to different conditions. For heavy silages the angle can be set more aggressive and for fragile crop a more gentle angle can be chosen.

Made from 10mm shot-peened spring steel and a coil diameter of 80mm, Super-C tines add up to the most durable and flexible tine in the market.*

“**An airy and evenly spread crop speeding up the drying process”**

Take the Lead in Beating the Weather

Vicon tedders help you produce high quality crop, even under difficult weather circumstances. Ever changing weather conditions often leave a very tight time window to prepare the crop. When the weather proves to be flexible, it is about vital machines which are ready to operate as flexible as needed.

The Vicon tedders are the right tool to accomplish uniform and rapid drying action of the crop. The Vicon Super-C tines, working with generous overlap thanks to the rotor design:

- equal length tines
- consistent burden
- longer service life
- easier warehousing
- direct initiation of turning operation



Optional third wheel lead to even more accurate track following and better tedding action.

*Compact line standard C-tines with coil 68 mm and 9 mm tines.

The Super-C Tine

In order to produce high quality silage or hay, the crop must be spread evenly across the field to facilitate a uniform drying process. In addition soil contamination is a no go. The symmetric Vicon Super-C tines of identical length efficiently pick up the crop and start turning of the crop already during the pickup process for fast effective wilting. The crop is spread evenly and thrown over a wide distance.

Tines with same lengths has the added advantage that load is spread evenly on both tines, providing longer lifetime.

The Vicon Super-C tines are made of 10mm shot-peened spring steel. Spring diameter coils have 20% larger diameters than conventional designs for added service life, even when tedding large quantities of crop.



Generous overlap ensures that crop is spread evenly.



Left: Super C-Tine 10mm
Right: Standard C-Tine 9mm

“**20% larger spring diameter** than conventional designs”

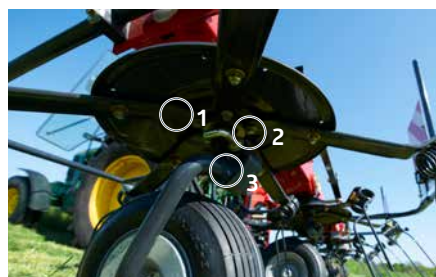

Setting the Right Spreading Angle

Simple three-way adjustment of wheel height, allows the optimum spreading angle to be achieved according to crop conditions, helping you to produce high quality forage.

Setting the rotors to the right spreading angle will improve considerably the spreading action and speed up the drying process. Set a steep angle for aggressive conditioning effect or choose the more flat angle for more gentle treatment of dry or very fragile material.

Easy adjustment of spreading angle via pin holes, no tools required.



Oscillation Dampers *for Smooth and Even Crop Distribution*



Oscillation Dampers

The Vicon oscillation dampers ensure excellent ground contour following and tedder flotation. The construction of the oscillation dampers results in a smooth and even distribution of the grass, due to the constant tine distance to the ground. The distant linkage point means that it offers excellent running characteristics compared to conventional oscillation dampers.

The fact that the linkage is positioned low on the headstock results in a more effective damping action during transport.



“**Smooth and even distribution of the grass**”

- Widely spaced mounting points - no risk of 'hunting'
- Excellent running characteristics
- Low-positioned linkage on the headstock for more effective damping action during transport
- No risk of the tedder mounting up driving downhill, excellent tedding at all times through constant tine spacing to the ground
- Maximum stability in transport position - no further lock of headstock required.

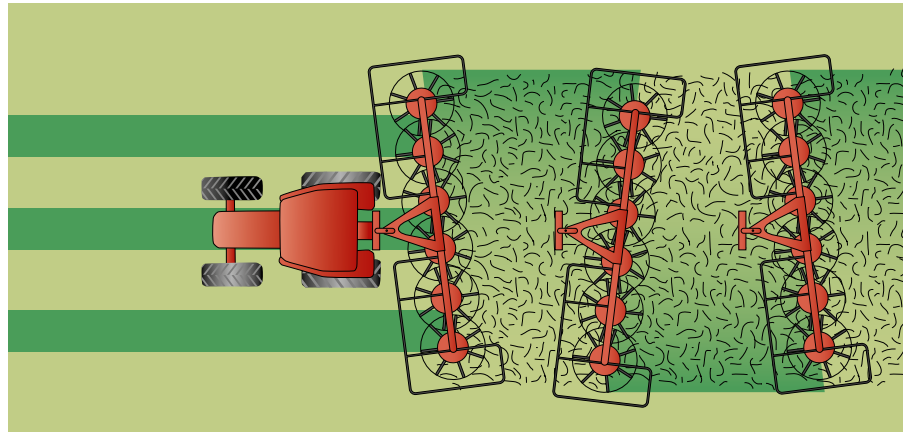

Conventional systems

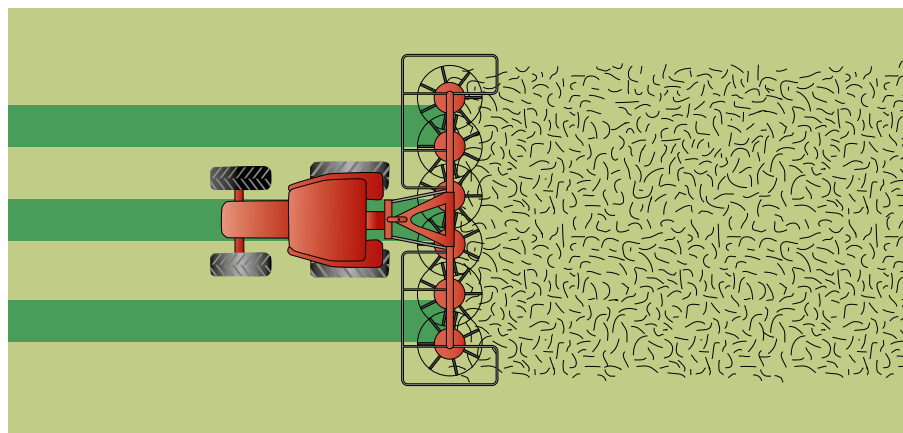

Vicon oscillation dampers

FANEX PROLINE ROTOR TEDDERS

My way of Farming!





ProLine



Fanex 1404C
Working Width: 13.3m



Fanex 904C- 1124C
Working Width: 9.0 - 11.2m



Fanex 554-684-764-904-1124
Working Width: 5.5 - 11.2m



High Capacity ***Tedders***



These tedders offer a new dimension in efficiency and stability. 10 rotors with 7 tine arms each can easily spread four 3.00m swaths. The solid design is your guarantee of a long lifetime, even when working in the toughest conditions. Its' large gears, sturdy shock proof bearings and oil-immersed drive system require zero lubrication.

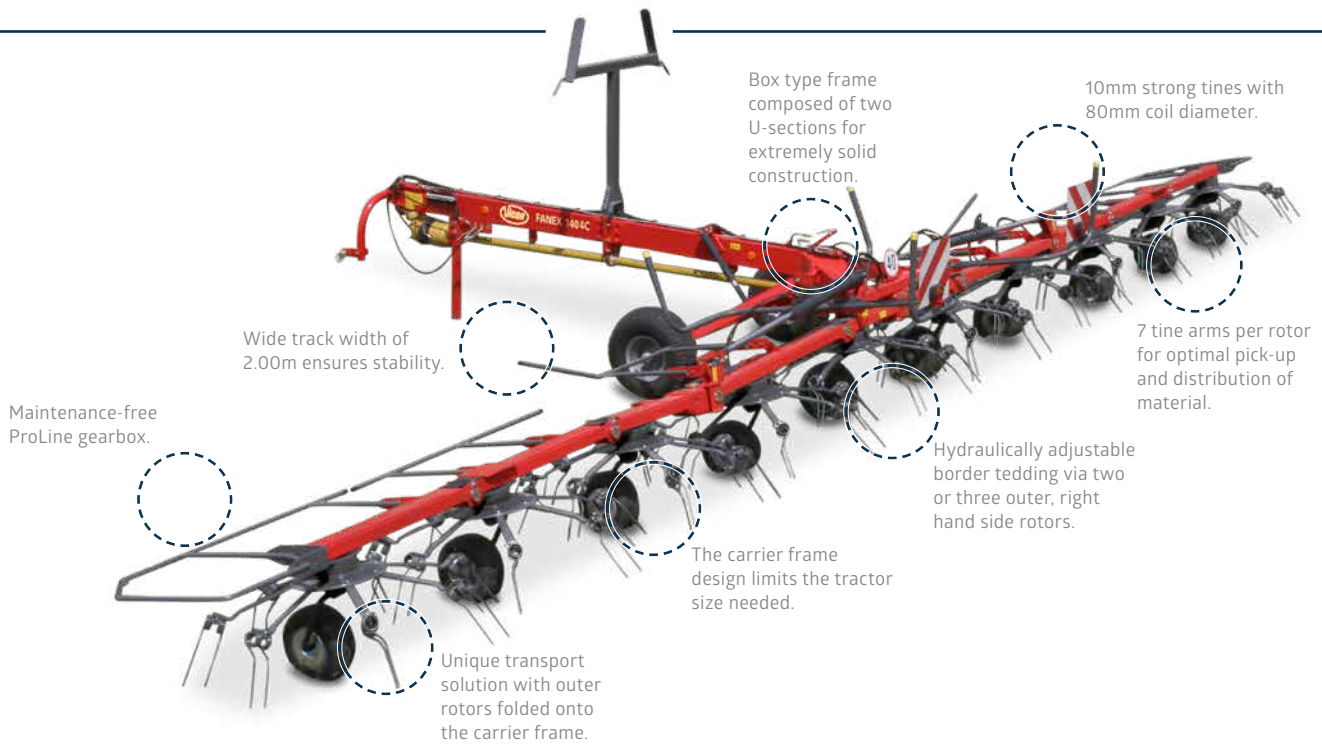

Box type frame composed of two U-sections for extremely solid construction.

10mm strong tines with 80mm coil diameter.

Wide track width of 2.00m ensures stability.

7 tine arms per rotor for optimal pick-up and distribution of material.

Maintenance-free ProLine gearbox.

Hydraulically adjustable border tedding via two or three outer, right hand side rotors.

The carrier frame design limits the tractor size needed.

Unique transport solution with outer rotors folded onto the carrier frame.

“Wide track width of 2.00m ensures stability”

Easy Handling

This easy to use machine is operated fully hydraulically and can be controlled from the tractor cab. High ground clearance and a wide wheelbase provide absolute road stability at high transport speeds. The folding mechanism and conversion to border tedding is hydraulic, and controlled from the tractor seat.

Minimum Maintenance

All vital parts are enclosed in a permanent oilbath for extreme durability and stability. The bearings offer a further innovation, with which the individual framework construction units are connected. The roller bearings of Fanex 1404C are life span lubricated. This absolutely maintenance-free kind of storage guarantees maximum stability and life span.



Strong and stable wheels for transport.



For border tedding the 3 outer rotors are pivoted, to secure evenly inward spreading.



80° turning angle ensures excellent manoeuvrability.



Unique *Transport Solution*



Fast and efficient conversion from transport to working position.

Excellent adaptation to ground contours, along with exceptional manoeuvrability.



“**Fast and efficient conversion**
from transport to working position”

Transport Height of Only 3.35m

The Fanex 1404C offers a unique transport solution that improves total work of the tedder. In transport position the outer rotors are folded forward onto a carrier frame.

In this way a transport height of only 3.35m, and a transport width of less than 3.00m is achieved. The carrier frame allows the tedders to move forward quickly and easily, when going from one field to another.



During transport both tedders have a height of only 3.35m.



Productivity *at the Core*



Strong and sturdy mainframe design with V-shaped central unit.



New aluminium rail guards, which are low in weight, but still extremely impact resistant.

Maintenance Made Easy

Powered by maintenance-free driveline and gearboxes, focus can be directed towards the essentials to maximize productivity. No time is wasted on time consuming greasing. Additionally the hinges are connected with strong maintenance-free roller bearings for extended longevity and stability of the connection points.



All tedders can be equipped with a third wheel to ensure correct set-up of the tedder independent of tractor and driver.

Heavy Duty Confidence

Vicon's new generation of mounted tedders is designed to perform perfect in all crop conditions, with a minimum of non-productive maintenance required and with diminished transport dimensions. Fanex 554 provides a working range of 5.5m, the 6-rotor Fanex 684 and 764 offer 6.8 and 7.6m working width, while the 8-rotor Fanex 904 spans 9.0m.

Featuring a heavy duty fully closed headstock and a strong V-shaped central unit, these machines will fit perfectly into the operation of professional farmers, looking for a strong, effective, and versatile tedder.

High Quality Tedding In all Conditions

- maintenance-free
- reduced efforts in season
- high loads transferring
- heaviest crop
- strong oscillation dampers
- even spreading pattern
- easy standard settings

“Perfect for all crop conditions – strong, effective and versatile!”

– strong,
effective and
versatile!”

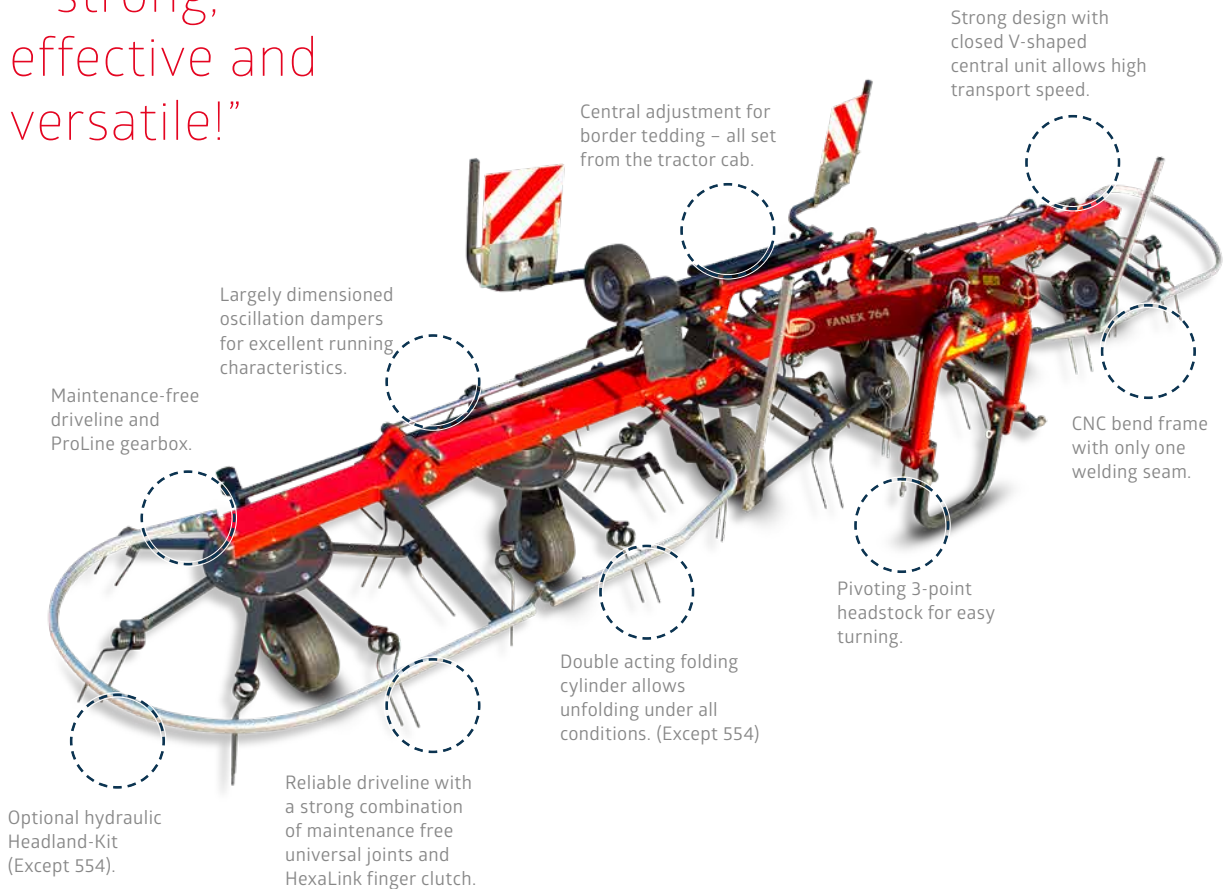



Reduced Transport Height – ***Increased Efficiency***



To increase productivity these tedders are equipped with the mechanical border tending device. Optional a hydraulic solution is available. A marker cleverly shows the position of the axle.

“**Compact in transport**
– new clever folding mechanism”



Compact in transport and during storage thanks to the new clever folding mechanism.



Fanex 684 in transport.

“**180° folding**
for transport”

Compact Transport Dimensions

These ProLine tedders offer very compact transport dimensions with their new clever folding solution. A reduced parking height is possible, due to the implementation of the HexaLink finger clutch system in the joints of the two outer rotors (Fanex 764 and 904). The remaining rotors are driven by double acting foldable cylinders*. They provide safe unfolding under all conditions.

*Except 554



Vicon HexaLink finger clutch permits a 180° folding of the rotors for transport. (Fanex 764, 904 and 1124 (C)).



A hydraulic headland kit is optionally available.*



Accurate Tedding *at High Capacity*



Fanex 1124 is fitted with the XL version of HexaLink finger clutch.

11m High Capacity Tedder

From heavy duty silage to hay making, the Fanex 1124 is designed to provide an excellent spreading job, significantly speeding up the drying process. Delivering 11.2m working width from 10 rotors, each fitted with 6 tine arms per rotor, the result is high performance and output.

Fanex 1124 is fitted with the new XL version of HexaLink finger clutch providing reliable power transfers and 180° folding of the rotors for transport.

Featuring a heavy duty fully closed headstock, the Fanex 1124 fits perfectly into the operation of professional farmers, looking for a strong, productive and versatile tedder.

Advantages:

- 10 rotor system
- small diameters
- optimal usage of working width
- no cable control for unlocking
- biggest 3-point tedder with 11.2m

“New folding mechanism – even weight distribution”



Compact transport dimensions of Fanex 1124 – storage height is only 3.80m.



With the optional electro-hydraulic headland kit with pilotbox, the machine can be raised while on headlands using the hydraulic control device.

Easy to Work With

The largest in the Vicon range of mounted rotary tedders comes with a folding mechanism, providing extra stability when folding on hilly terrain. This ensures even weight distribution during the complete folding sequence. Thanks to the new HexaLink finger clutch system, the Fanex 1124 folds into very compact transport and storage dimensions. Despite its impressive working width of 11.2m, this rotary tedder offers storage height as low as 3.85m and a transport width of only 2.95m.



New folding mechanism – ensures even weight distribution during the complete folding sequence.



Designed for Compact Tractors *Starting From 60hp*



Clever Transport Solution

The new Fanex 904C is a 9m, 8-rotor and the 1124C with 11.2m and 10 rotors carrier frame tedder purpose-built for use with smaller tractors. The wide track width ensures stable running characteristics during road transport. Due to the carrier frame concept, the lifting capacity of the tractor is not a limiting factor and it can be operated with tractors starting from 60hp.

In road transport, tedder weight rests on the running gear, rather than on the tractor's rear axle. The optimised driveline provides low input requirement, so you can easily use a small tractor and still work at wide working widths - the ideal solution that saves fuel and running costs.



Tandem axle (option).



Get the most out of your crop. With border tending you keep the crop inside the field. The tedder is swung hydraulically into border position, conveniently tending the crop away from the border line.



New optional third wheel with tandem axle for high accuracy in ground followings.

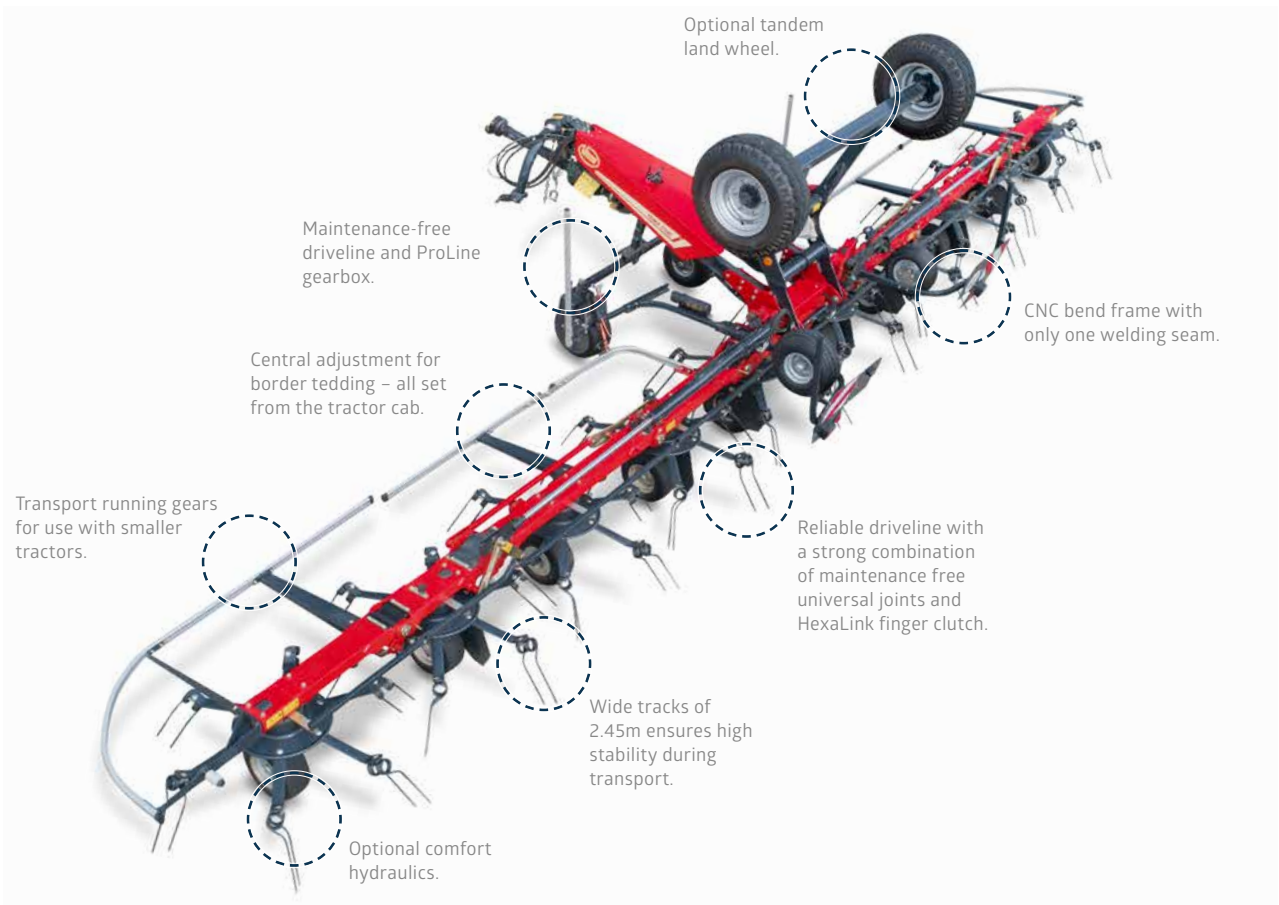



Reliable Performance *with Smart Transport Solution*

The Carrier Frame Takes the Strain

The carrier frame concept of a Fanex 904C and 1124C allows to be managed with smaller tractors than conventional sizes. These two models offer very compact storage and transport height due to the implementation of the HexaLink finger clutch system in the joints of the two outer rotors.

Vicon Fanex 904C = 3.74m
Vicon Fanex 1124C = 3.94m

The remaining rotors are driven by maintenance-free universal joints, for strong and efficient transfer of power, including the possibility of running in folded position.



“ **Hydraulically converting** from transport to working position”



Standard running wheels of Fanex 904C are extra wide 10.0/75 – 15.3 tyres with a generous track width of 2.45m.



From transport to working position:

Fanex 904C easily converts from transport to working position and fold hydraulically.

FANEX COMPACTLINE ROTOR TEDDERS

My way of Farming!





CompactLine



Fanex 604-804
Working Width: 6.05-8.05m



Fanex 464-524
Working Width: 4.6-5.2m



The Hay Making *Tedders*

Fanex 604 folds hydraulically from working to transport position and vice versa.





The strong design of the V-shaped central unit provides high stability during tedding operation and allows high transport speed.



Standard oscillation dampers ensure an even spreading pattern.

Powerful Dimensions

Fanex 604 and Fanex 804 come with a strong package of Vicon features, such as 2 oscillation dampers, strong V-shaped central unit and central adjustment for border tedding.

They offer considerable working width with their combination of 6/8 rotors and 6.05m/8.05m working width.

The very small rotors are especially designed for optimized performance while producing dry hay, but will fit any kind of crop. The compact rotors, in combination with a big overlap, ensure complete pick-up of the grass and equal distribution over the entire working width.

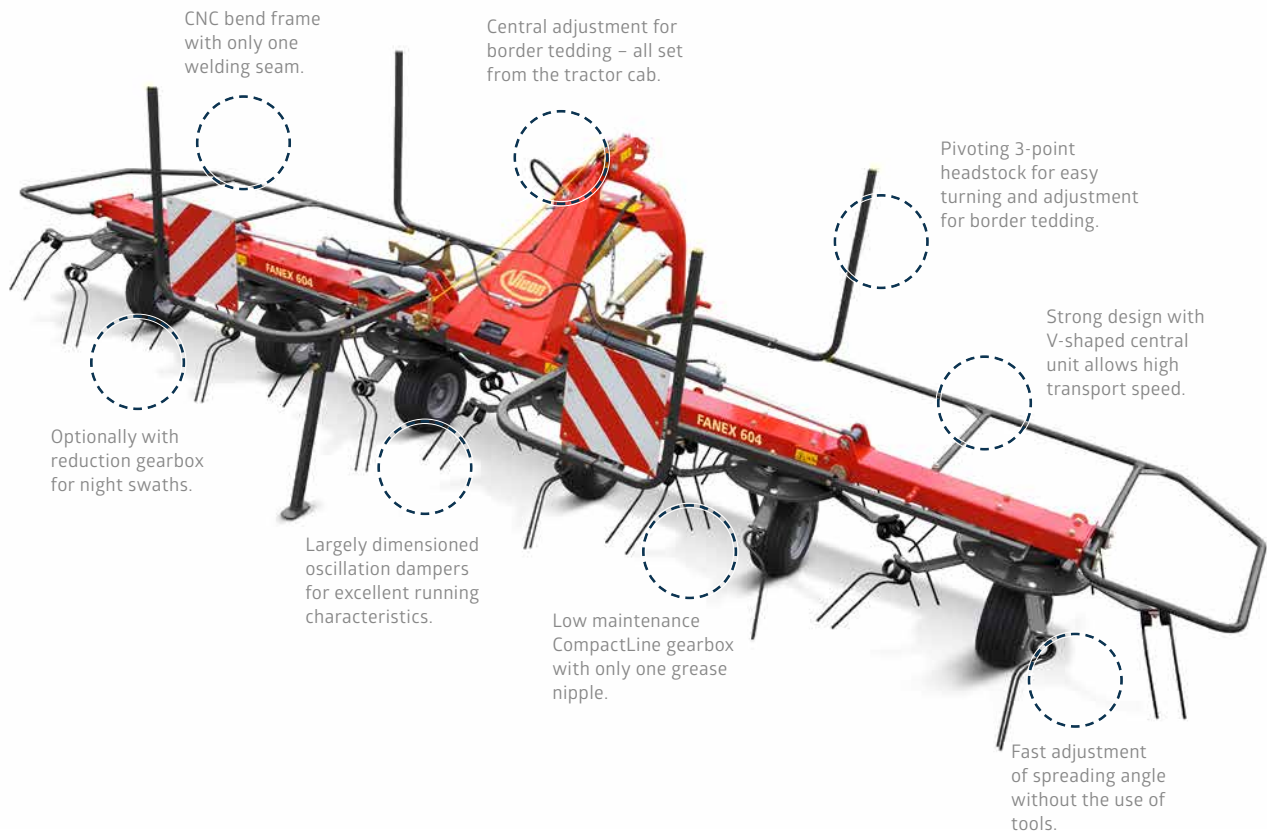

CNC bend frame with only one welding seam.

Central adjustment for border tedding – all set from the tractor cab.

Pivoting 3-point headstock for easy turning and adjustment for border tedding.

Strong design with V-shaped central unit allows high transport speed.

Optionally with reduction gearbox for night swaths.

Largely dimensioned oscillation dampers for excellent running characteristics.

Low maintenance CompactLine gearbox with only one grease nipple.

Fast adjustment of spreading angle without the use of tools.



Achieve More *with Fanex 804!*

Compact Folding for Transport

Despite its 8.05m working width the Fanex 804 will fold into a very compact unit for transport, and will go below 3.00m transport width. The two outer rotors are fitted with the new Vicon HexaLink finger clutch, a simple yet efficient drive system. The remaining rotors are driven by double universals joint, providing sturdy and efficient transfer of power.

Built to Last – Minimum Maintenance

The Fanex 804’s superior durability and ease of maintenance ensure maximum machine uptime. It is designed with a strong package of Vicon features such as 2 oscillation dampers and strong V-shaped central frame unit for stable and accurate running characteristics.

The rotor gearbox is designed to just keep going and only requires greasing once per season of just one point. Additionally the unfolding process is done via double acting cylinders, for troublefree operation under all conditions.



Fanex 804 folds into a very compact position for transport.



Compact dimensions during storage.



Vicon HexaLink finger clutch permits the rotors to fold 180° for transport.

“**Compact dimensions** during storage”



Easy adjustment of spreading angle.



With the optional reduction gearbox it is possible to place night swaths.



Hydraulic border tedding (option).



Compact – *Easy to Maintain*

Low Maintenance

With working widths of 4.60m and 5.20m, Vicon offers the CompactLine range with low maintenance rotor gearboxes. The rotors of the Fanex 464 and 524 are driven by a low maintenance gearbox with only one grease nipple.

The double bearings from pinion to crown wheel guarantee maximum longevity of the driveline. The low weight of these models is ideal for application with small tractors, or in hilly regions.



All tedders fold hydraulically from working to transport position and vice versa.

Incredible Dimensions

Even the smallest models excel – the rotor plate diameter measures 500mm! All Fanex tedders feature gearboxes flanged to the frame, and which have no supporting function, and are therefore not subjected to any strain.

This system sets the benchmark with respect to stability, smooth running, quality of work and efficiency. Compare for yourself.

All models are fitted with a central adjustment device for setting the machine at the correct angle for border tedding. This is set mechanically from the tractor cab and is done in very few seconds. Optionally hydraulic operation is available too.

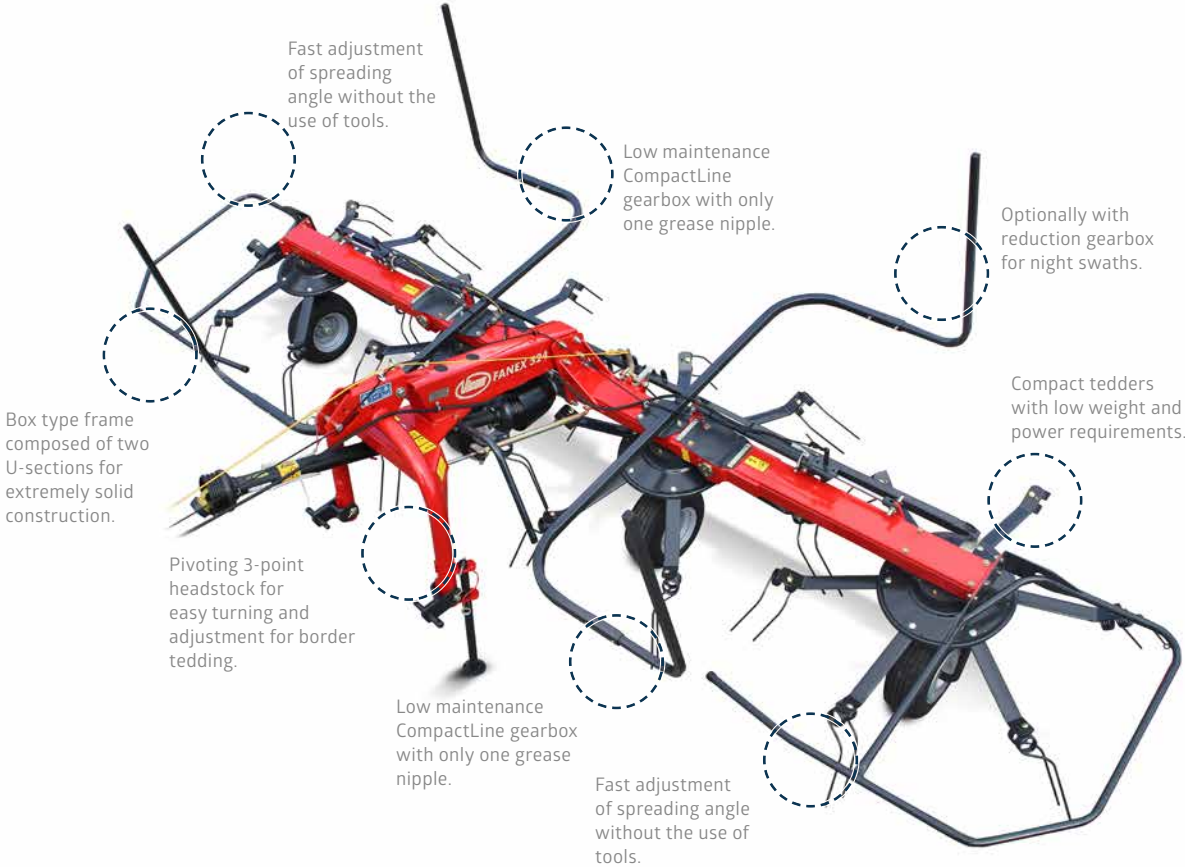

Fast adjustment of spreading angle without the use of tools.

Low maintenance CompactLine gearbox with only one grease nipple.

Optionally with reduction gearbox for night swaths.

Box type frame composed of two U-sections for extremely solid construction.

Pivoting 3-point headstock for easy turning and adjustment for border tedding.

Low maintenance CompactLine gearbox with only one grease nipple.

Compact tedders with low weight and power requirements.

Fast adjustment of spreading angle without the use of tools.



Powerful *Dimensions*



Keep the crop inside the field with border tedding.



As an option the tedders can be equipped with a third wheel to improve contour followings.



Standard oscillation dampers ensure an even spreading pattern.



Optional reduction gearbox makes night swath tedding possible.

**“Centrally
adjustment
for border
tedding”**



Fanex 464 and Fanex 524 are centrally adjusted for border tedding.

Original Parts & Service

We are here so you can focus on your crop

- 
- 1 Long lasting, high quality spare parts**
 - 2 Over 100 years of parts knowledge**
 - 3 Support from a wide network of dealers**
 - 4 24/7 spare parts service**
 - 5 Highly skilled dealer technicians**



“**MYVICON**
Connected farming, my way”

A personalised online platform tailored to your machine needs

With MYVICON you will benefit from easy access to Vicon's online service tools. Receive first hand access to information on future developments and updates, operator and spare part manuals, FAQs and local VIP offers. All information is gathered in one place.



**REGISTER YOUR PRODUCT NOW:
MY.VICON.EU**

Facts

Model Fanex	CompactLine			
	464	524	604	804
Dimensions & Weights				
Working width* (m)	4.60	5.20	6.05	8.05
Working width* (feet)	(15'1")	(17'1")	(19'10")	(26'5")
Width, working position (m)	5.00	5.40	6.40	8.35
Width, working position (feet)	(16'5")	(17'9")	(20'12")	(27'5")
Transport width (m)	2.85	2.90	2.75	2.90
Transport width (feet)	(9'4")	(9'6")	(9')	(9'6")
Transport length (m)	2.15	2.10	1.86	1.90
Transport length (feet)	(7'6")	(6'11")	(6'17")	(6'23")
Storage height (m)	2.45	2.65	3.10	3.15
Storage height (feet)	(8')	(8'8")	(10'2")	(10'33")
Weight approx. (kg)	500	530	650	920
Weight approx. (lbs)	1102	1168	1433	2028
Capacity theor. (ha/h)	3.7	4.2	4.8	6.4
Attachment				
Three-point, tracking	1/2	1/2	1/2	2
Linkage drawbar	-	-	-	-
Two-point, linkage arms	-	-	-	-
Oscillation damper/integral lock	●	●	●	●
Rotors/Tines/Guard				
No. of rotors	4	4	6	8
No. of tine arms / rotor	5	6	5	5
Tine adjustment system	●	●	●	●
Adjustment of spreading angle	●	●	●	●
Cab contr. border clearing system, Mechanical	●	●	●	●
Cab contr. border clearing system, Hydraulic	0	0	0	0
Reduc. gearbox for night swaths	0	0	0	0
Tyres/Axles/Lights				
Wheels	16x 6.5-8	16x 6.5-8	16x 6.5-8	16x 6.5-8
Tyres on central unit	-	-	-	-
Front wheel (16x6.50-8)	0	0	0	0
Tandem axles	-	-	-	-
Warning panels	0	0	0	0
Warning panels, with integr. lighting	0	0	0	0

● Standard 0 Optional - Not available * DIN 11220









ProLine							
554	684	764	904	904C	1124	1124C	1404C
5.50	6.80	7.60	9.00	9.00	11.20	11.20	13.30
(18'1")	(22'4")	(24'11")	(29'6")	(29'6")	(38'8")	(38'8")	(43'8")
5.80	7.15	7.90	9.45	9.45	11.70	11.70	13.80
(19')	(23'5")	(25'11")	(31')	(31')	(38'35")	(38'35")	(45'3")
2.98	2.92	2.96	2.94	2.94	2.94	2.96	2.98
(9'9")	(9'7")	(9'9")	(9'8")	(9'8")	(9'65")	(9'71")	(9'9")
2.30	2.20	2.26	2.16	4.21	2.16	4.26	6.20
(7'7")	(7'3")	(7'5")	(7'1")	(14')	(7'7")	(13'9")	(20'4")
2.80	3.52	3.46	3.49	3.74	3.80	3.94	3.35
(9'2")	(11'7")	(11'4")	(11'5")	(12'3")	(12'43")	(12'93")	(10'1")
640	900	990	1260	1700	1600	2225	2300
1410	1984	2183	2778	3747	3527	4905	5071
4.4	5.4	6.1	7.2	7.2	9.0	9.0	10.7
2	2	2	2	-	2	-	-
-	-	-	-	-	-	-	-
-	-	-	-	2	-	2	2
●	●	●	●	-	●	●	-
4	6	6	8	8	10	10	10
7	6	7	6	6	6	6	7
●	●	●	●	●	●	●	●
●	●	●	●	●	●	●	●
●	●	●	●	-	●	-	-
0	0	0	0	●	0	●	●
0	0	0	0	0	0	0	0
16x	16x	16x	16x	16x	16x	16x	16x
6.5-8	6.5-8	6.5-8	6.5-8	6.5-8	6.5-8	6.5-8	6.5-8
-	-	-	18.5x	18.5x	18.5x	18.5x	18.5x
			8.5-8	8.5-8	8.5-8	8.5-8	8.5-8
0	0	0	0	0	0	0	-
0	0	0	0	-	0	0	-
0	0	0	●	●	●	●	●
0	0	0	●	●	●	●	●

Safety devices may have been removed from the machines for illustration purposes only, in order to better present functions of the machines. To avoid risk of injury, safety devices must never be removed. If removal of safety devices is necessary, e.g. for maintenance purposes, please contact proper assistance or supervision of a technical assistant. ® = trade mark protection in the EU. © Kverneland Group Kerteminde AS

Facts

The Right Tedder for Every Cutting Width



ProLine	 ROTORS	 ROTOR WIDTH	 ROTOR TINES	 WORKING WIDTH
FANEX 1404C	10	1760mm	7	13,30m
FANEX 1124/1124C	10	1560mm	6	11,20m
FANEX 904/904C	8	1560mm	6	9,00m
FANEX 764	6	1660mm	7	7,60m
FANEX 684	6	1560mm	6	6,80m
FANEX 554	4	1760 mm	7	5,50m
CompactLine	 ROTORS	 ROTOR WIDTH	 ROTOR TINES	 WORKING WIDTH
FANEX 804	8	1420mm	5	8,05m
FANEX 604	6	1420mm	5	6,05m
FANEX 524	4	1660mm	6	5,20m
FANEX 464	4	1560mm	5	4,60m

WORKING WIDTH* / SWATHES**

	1.6m	2.0m	2.4m	2.8m	3.2m	3.5-3.6m	4.0m	8.7m	9.0m	9.5m	10.2m

WORKING WIDTH* / SWATHES**

	1.6m	2.0m	2.4m	2.8m	3.2m	3.5-3.6m	4.0m	8.7m	9.0m	9.5m	10.2m

*only full working width covering pictured
 **based on average swath width

Proud History of Ground Breaking Innovations

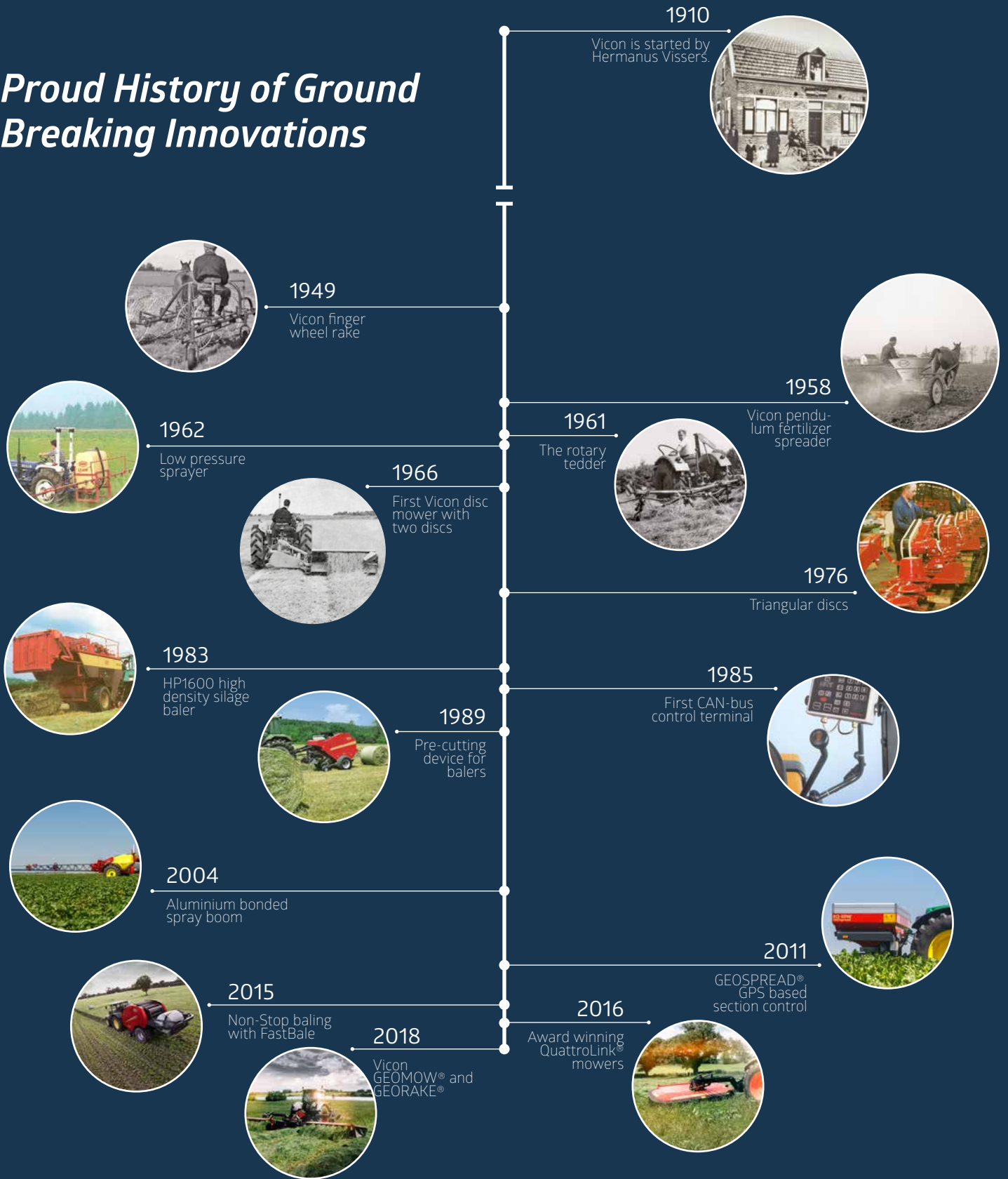

My way of Farming!



www.vicon.eu